

COMMITTED TO NORTH AMERICA

NSK manufactures and services innovative linear motion and control products in the US. NSK linear guides can be found in many applications within the automotive, semiconductor, food and beverage, medical, machine tool and packaging industries.

To respond quickly and efficiently to the unique challenges of our customers, NSK distribution centers, manufacturing facilities and sales offices are strategically located throughout the Americas.

Customers can trust NSK to provide the highest quality linear motion products, total application solutions and world-class engineering support. U.S. manufacturing gives NSK the flexibility to quickly respond to your needs – whether you require a next-day modification, or rush repair and maintenance services after the sale.

AROUND THE GLOBE

The NSK Group is one of the world's leading manufacturers of motion and control products. A global company with sales of over \$8.7 billion, NSK employs over 31,500 employees at 64 ISO certified manufacturing facilities. Our 120 sales operations are located in 29 countries around the globe.

With over 100 years of experience, NSK products and solutions have been chosen by leading brands around the world. As an industry innovator, NSK can help you lead the way by delivering high quality motion and control solutions.

LOCAL SOLUTIONS

NSK's 75,000 sq. ft. manufacturing facility in Franklin, Indiana is dedicated to manufacturing precision products and serving the Americas markets. Certified to ISO9001:2008 and ISO14001:2004 standards, this state-of-the-art plant ensures shorter manufacturing lead times and quicker turnaround to meet the needs of customers from coast to coast.

With unique domestic services including rail cutting and custom configurations, NSK can meet your deadline.



NSK Americas' Headquarters
Ann Arbor, MI

NSK LINEAR GUIDES

PRODUCT RANGE



NH/NS Series

Interchangeable Linear Guide

- › Easier installation with high self-aligning capabilities
- › Interchangeable parts for quick repair and replacement
- › Short delivery time
- › Ideal for general industry
- › Extended product life with K1™ Lubrication Units
- › Long life (up to 2x than previous LH/LS series)
- › High speed
- › Low noise

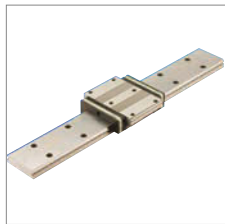

LW Series

Wide Rail Linear Guide

- › Wide rail offers high rigidity and load capacity
- › Interchangeable parts for quick repair and replacement
- › Low profile for compact design
- › Ideal for general industry
- › Extended product life with K1™ Lubrication Units

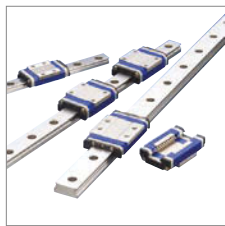

PU/PE, LU/LE Series

Miniature Linear Guide

- › Low dust generation to keep your equipment clean
- › High corrosion resistant stainless steel
- › Extended product life with K1™ Lubrication Units
- › Interchangeable parts for quick repair and replacement
- › Ideal for medical and semiconductor industries



RA and RB Series

High Rigidity Roller Guide

- › Super high rigidity for greater accuracy
- › The world's highest load capacity
- › Dustproof to extend product life
- › Rail covers offer extra sealing for even longer life
- › RB series offers low profile design
- › Interchangeable parts for quick repair and replacement
- › Ideal for the machine tool industry
- › Extended product life with K1™ Lubrication Units



V1 Series

Contaminated Environment Linear Guide

- › High performance seals reduce the entry of contaminants to extend product life by up to 5x that of standard NSK linear guides
- › Cleaner operation and extended product life with K1™ Lubrication Units
- › Ideal for highly contaminated areas

ACCESSORIES



K1™ Lubrication Units

Maintenance-free Lubrication

- › Extended lubrication life
- › Less risk of mechanical failure
- › FDA Compliant Unit available



LG2/LGU

Clean Room Grease

- › Low particle emission to keep equipment clean
- › High durability reduces upkeep costs
- › Rust prevention ability is significantly higher than fluorine greases



HP Seals

High Performance Seals

- › With seal's multi-lip structure, entry of foreign matter is reduced by 1/10 when compared to NSK linear guides without a high performance seal
- › Product life is extended up to 5x of standard NSK linear guides



Rail Covers

Contamination Protection for Rails

- › Covers entire rail to prevent contamination from building up in the rail mounting holes (RA series only)



Special Coatings

Special Coatings for Harsh Environments

- › **Armoloy®** – a hard, protective coating provides corrosion resistance plus increased durability
- › **Black Chrome** – provides corrosion resistance
- › **Fluoride Black Chrome** – offers higher corrosion resistance than standard black chrome and is preferred for applications using acid or other harsh chemicals

NSK LINEAR GUIDES

Table 1: Preload Code

Preload	P/N Code
Fine Clearance, Z0	0
Slight Preload, Z1	1
Medium Preload, Z3	3
Heavy Preload, Z4 (LA Series)	4
Interchangeable Fine Clearance, ZT	T
Interchangeable Slight Preload, ZZ	Z
Interchangeable Medium Preload, ZH	H

Table 3: Accuracy Code

Accuracy	Without NSK K1™	With NSK K1™
Ultra precision grade	P3	K3
Super precision grade	P4	K4
High precision grade	P5	K5
Precision grade	P6	K6
Normal grade	PN	KN
Normal interchangeable grade	PC	KC

Table 2: Material/Surface Treatment Code (For Custom Assembly Only)

Code	Description
P	Special high carbon steel + high performance seal
R	Special high carbon steel + surface treatment + high performance seal
T	Stainless steel + high performance seal
U	Stainless steel + surface treatment + high performance seal
C	Special high carbon steel (NSK standard)
K	Stainless steel
D	Special high carbon steel with surface treatment
H	Stainless with surface treatment
Z	Other, special

APPLICATION EXAMPLES

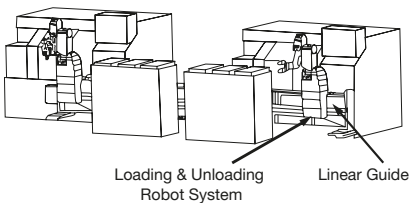

Loading and Unloading Robot

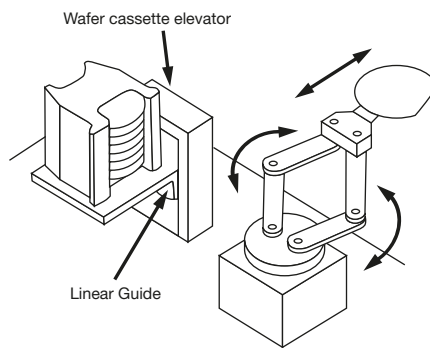

Wafer Cassette Elevator

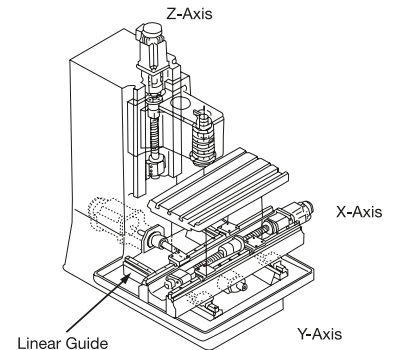

Machine Center

LINEAR GUIDE PRODUCT SELECTION

Answer the following questions to determine the appropriate NSK product.

1. What is your application?
2. Do you have a part # (from NSK or a competitor)?
3. If so, how did you arrive at the part # you selected?
4. What type of carriage or bearing style is needed for your application: tapped, through hole, square or flange style?
5. How many carriages or bearings are needed per rail?
6. What rail length do you require?
7. What are your accuracy and preload requirements?
8. What is the G dimension? (See below)
9. Accessories - do you need K1™ Lubrication Units, high performance seals, metal seals, rail or bolt hole covers or special coatings?
10. What is your expected delivery date?
11. What is the load applied to the assembly?
12. What is the maximum temperature of your application?
13. What type of environment does this application run? (ex. cleanroom, vacuum, etc.)
14. At what speed does your application run?
15. What is the required life of this linear guide?

G DIMENSION INFORMATION

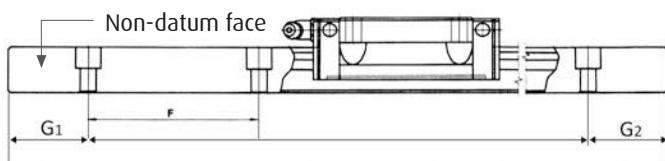

In order to properly cut linear guide rail, the G dimension must be determined. The G dimension is the dimension from the end of the rail length to the center of the first bolt-hole. In certain applications, we will need to know the G dimension for both ends of the rail.

NSK LINEAR GUIDE PART NUMBERING SYSTEM

PRELOADED ASSEMBLY NOMENCLATURE

Reference number coding for assembled ball slide: NH and VH Series

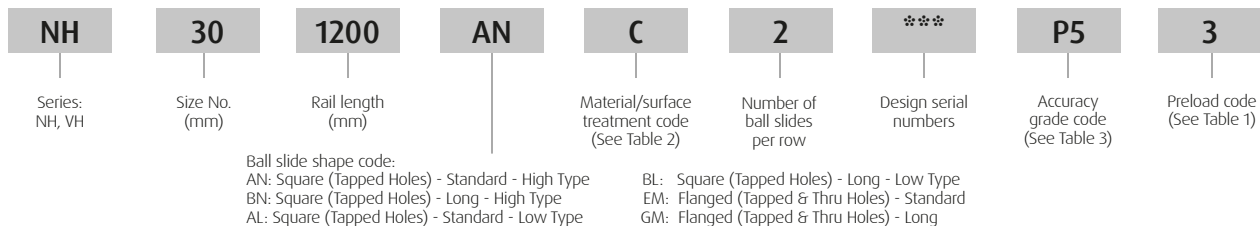

Reference number coding for assembled roller slide: RA and RB Series

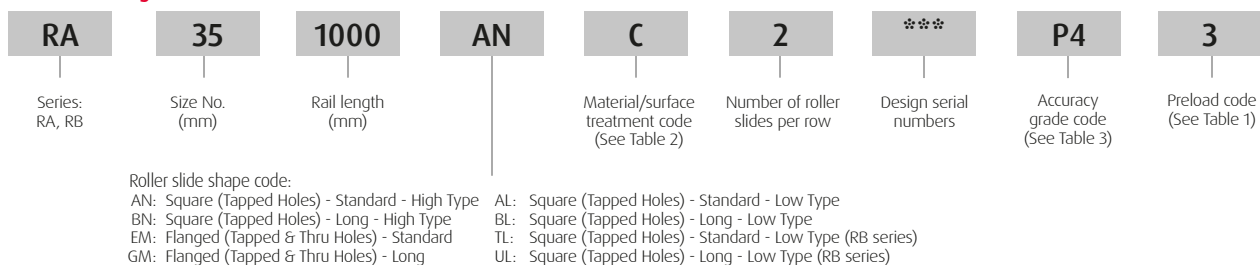

Reference number coding for assembled ball slide: NS Series

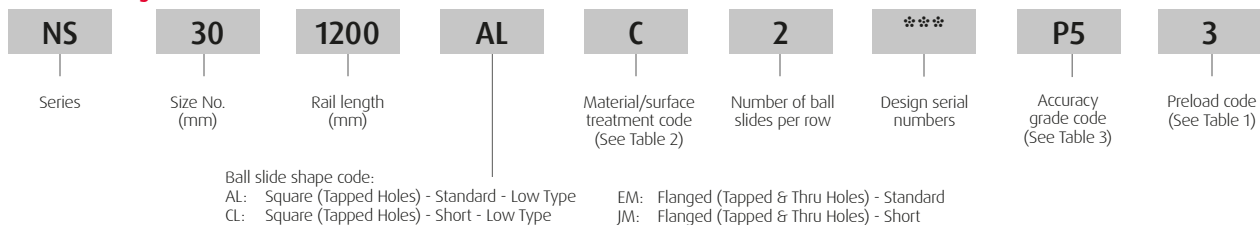

Reference number coding for assembled ball slide: LW Series

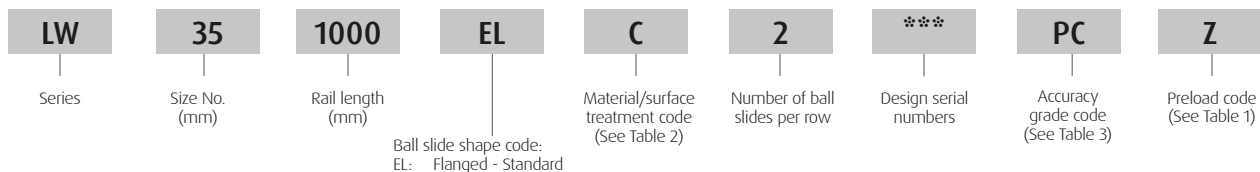

Reference number coding for assembled ball slide: PU/PE Series

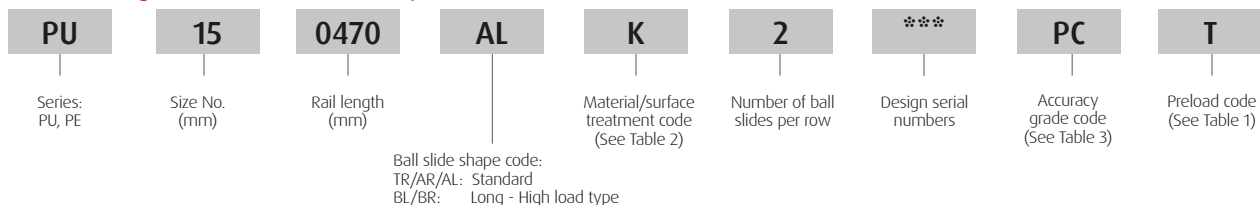

Reference number coding for assembled ball slide: LU/LE Series

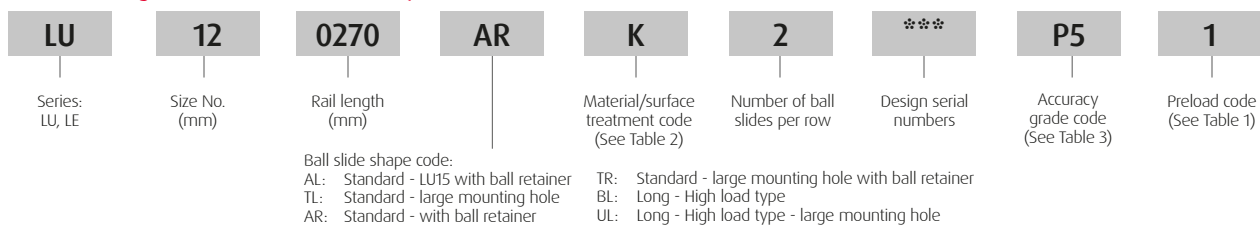

NSK LINEAR GUIDE INTERCHANGEABLE SLIDE AND RAIL NOMENCLATURE

NH Series Ball Slide

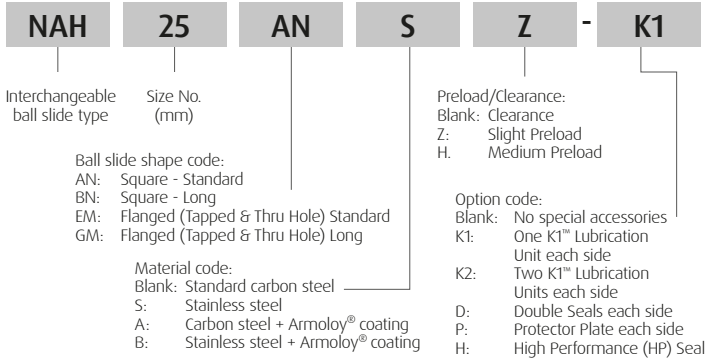

NH Series Rail

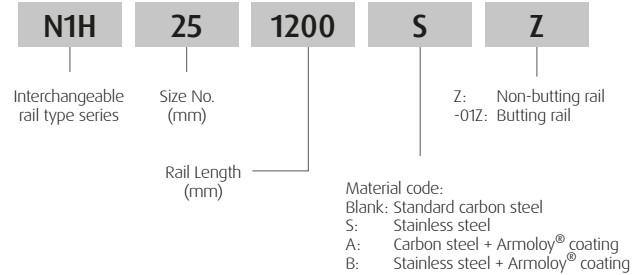

NS Series Ball Slide

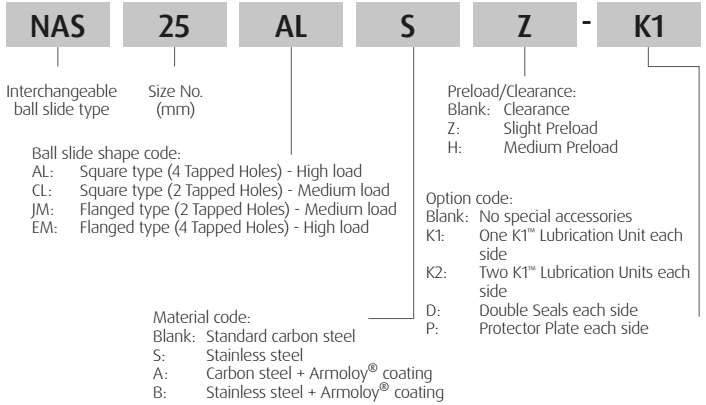

NS Series Rail

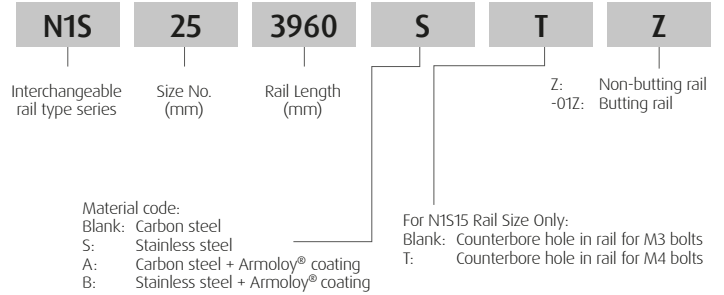

PU/PE Series Ball Slide *

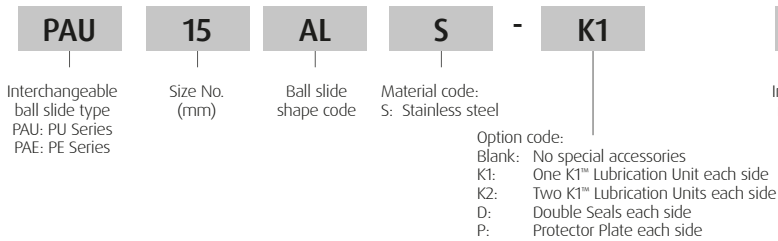

PU/PE Series Rail *

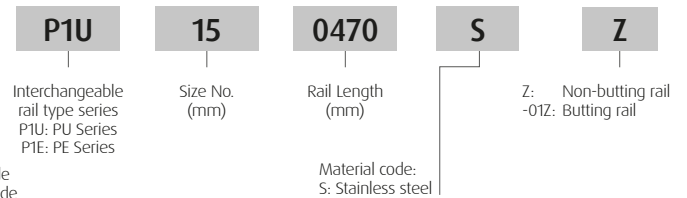

* Interchangeable rails and slides are available for PU/PE sizes 09, 12, & 15 only.

LU/LE Series Ball Slide

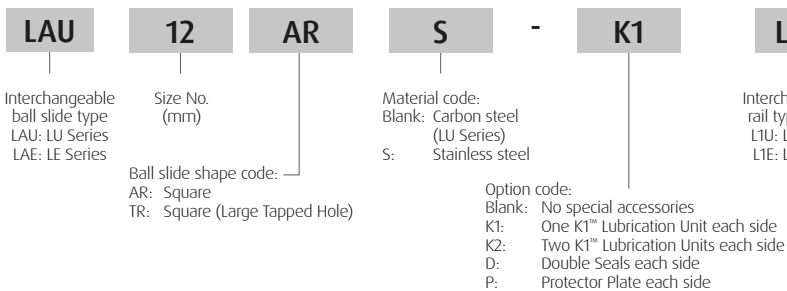

LU/LE Series Rail

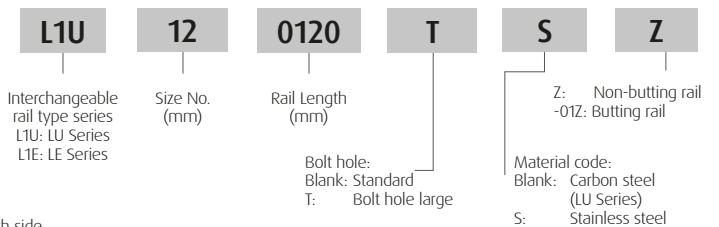

NSK LINEAR GUIDE INTERCHANGEABLE SLIDE AND RAIL NOMENCLATURE

LW Series Ball Slide

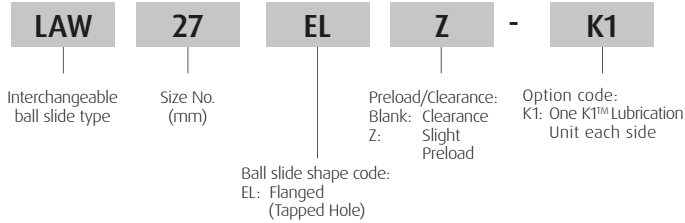

LW Series Rail

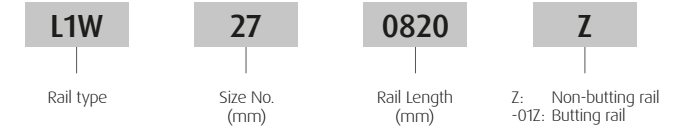

RA Series Roller Slide

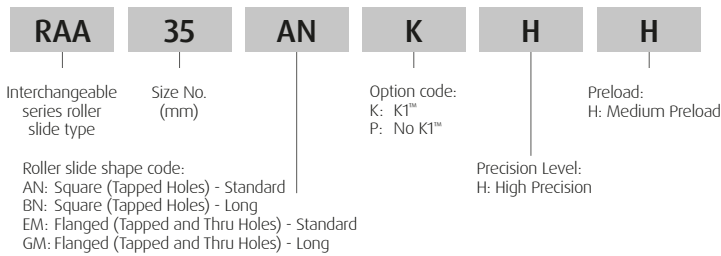

RA Series Rail

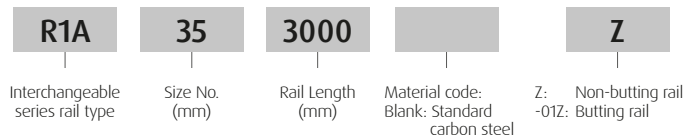

NSK LINEAR GUIDE, INTERCHANGEABLE SLIDE AND RAIL (ASSEMBLED) NOMENCLATURE

Interchangeable rails and slides for random matching are available for **NH, NS, LW, PU, PE, LU, LE** and **RA Series**. The rails and slides may be purchased separately.

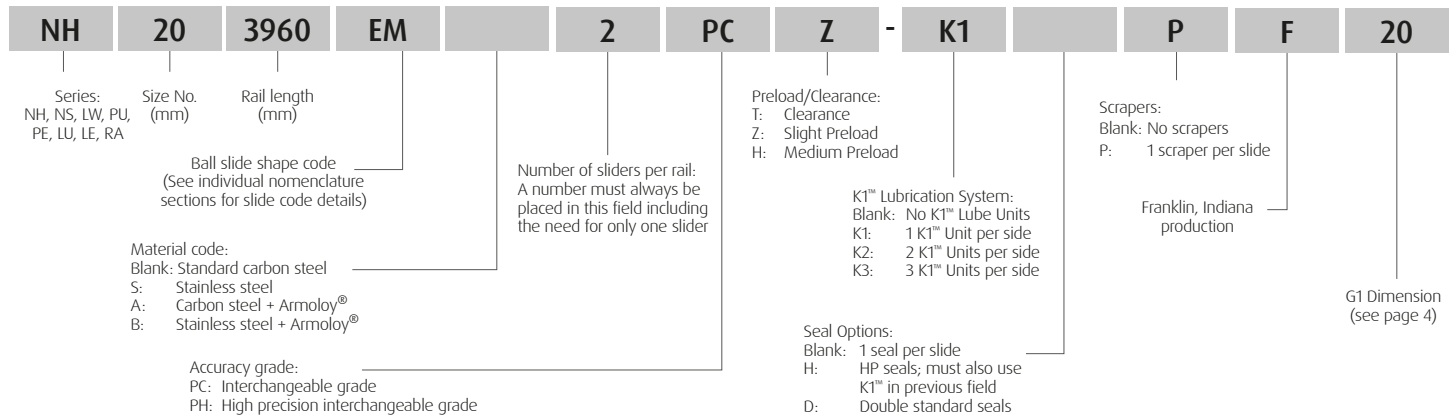

CAD Files and Technical Information



SolidComponents™

NSK has partnered with SolidComponents™ to offer you easy access to CAD files and technical information. Visit SolidComponents (<http://npa.solidcomponents.com>) to download CAD files and technical information.



NSK AMERICAS

Argentina

NSK Argentina SRL
Buenos Aires
54.11.4762.6556

Brazil

NSK Brasil Ltda.
Sao Paulo SP
55.11.3269.4700

Canada

NSK Canada Inc.
Mississauga ON
1.877.994.6675

Latin America

NSK Latin America Inc.
Miami FL
1.305.477.0605

Mexico

NSK Rodamientos Mexicana, S.A. de C.V.
Tlaine pantla de Baz MX
52.55.3682.2900

United States

NSK Corporation
Ann Arbor MI
1.888.446.5675

Website: www.nskamericas.com

NSK Global: www.nsk.com

Every care has been taken to ensure the accuracy of the data contained in this brochure, but no liability can be accepted for any loss or damage suffered through errors or omissions.

Printed in the USA ©NSK 2018. The contents of this publication are the copyright of the publishers.