

MOLDED-OIL BEARINGS

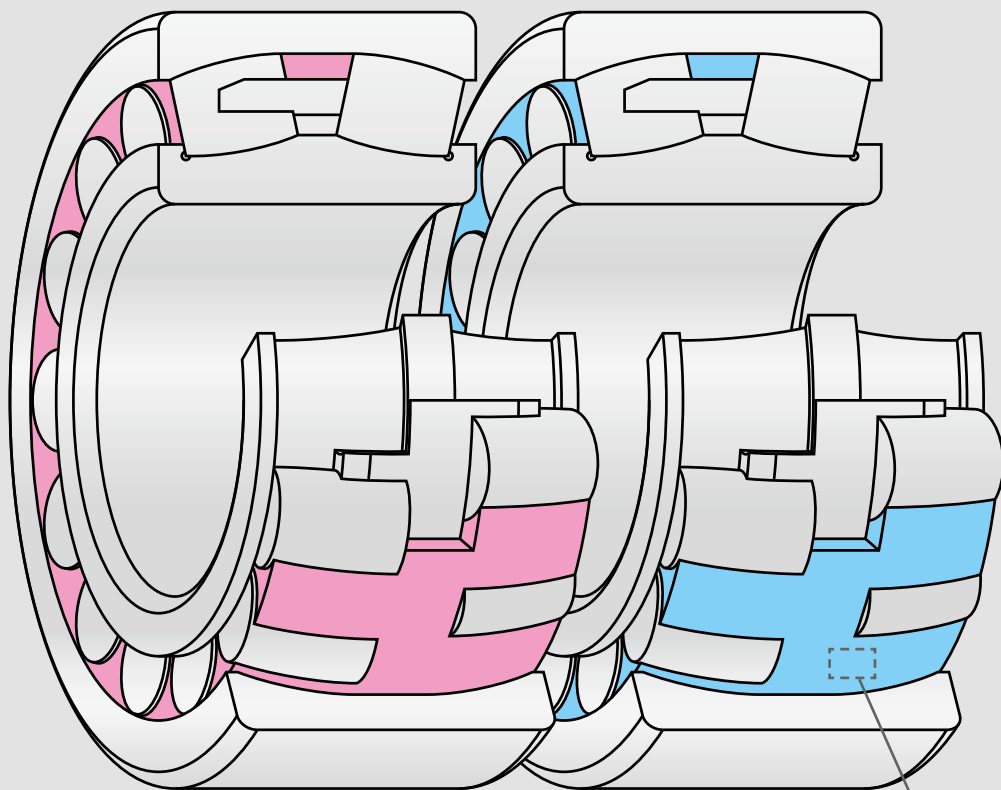

Molded-Oil Bearings

- For general use
- For high-speed operation



Portion containing mostly polyolefin

Polyolefin is used for packaging food in supermarkets, replacing dioxin-generating vinyl chloride.

Portion containing mostly lubricating oil

The lubricating oil is mineral oil-based.

Close-up of Molded-Oil

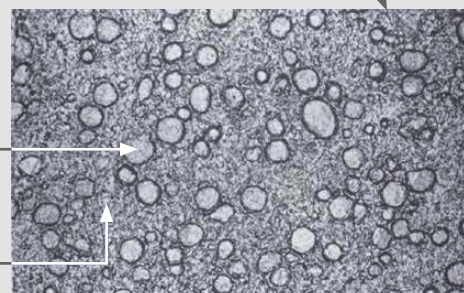

100 μm



Molded-Oil Bearings are lubricated with NSK's own oil-impregnated material – Molded-Oil – which consists of lubricating oil and polyolefin resin that has an affinity for oil. Lubricant slowly seeping from this material provides ample lubrication to the bearing for extended periods.

Features of Molded-Oil Bearings

› **Excellent performance in water- and dust-contaminated environments**

The bearings are designed to prevent liquids such as water (which can wash the lubricating oil out) and dust from getting inside the bearings. Sealed types can be used in environments exposed to water and dust.*

› **Environmentally friendly**

Because they can be lubricated with minute quantities of oil that exudes from Molded-Oil, the bearings are able to minimize oil leakage.

› **Low torque**

Packing with Molded-Oil after providing the bearing surface with special treatment realizes smooth rotation of rolling elements.

› **Optimal composition and molding methods enable high-speed operation of Molded-Oil Bearings**

Optimization of composition and molding method of Molded-Oil improves strength and enables high-speed operation of Molded-Oil Bearings.

Applications

- › Steel mill equipment
- › Paper mill equipment
- › Liquid crystal display and semiconductor manufacturing equipment
- › Agricultural machines
- › Food processing equipment
- › Cleaning equipment and lines
- › Conveying equipment

* Water and dust dramatically accelerate bearing damage. In order to realise stable operation, we recommend using seals to prevent water and dust from getting in the bearing.

Molded-Oil Bearings



Spherical roller bearing
22311L12CAM

- › For high-speed operation



Deep groove ball bearings*
6206L12DDU

- › For high-speed operation



Spherical roller bearing
22311L11CAM

- › For general use



Deep groove ball bearings*
6206L11DDU

- › For general use



Deep groove ball bearings*
6000L11-H-20DD

- › For general use



Tapered roller bearing
HR32013XJL11

- › For general use

* The bearings come with seals on both sides.

Bearing Model Numbers

Handling Precautions

To maintain the excellent long-term lubricating capacity of Molded-Oil Bearings, the following precautions should be observed:

- › Molded-Oil melts at about 120°C, therefore the bearings must not be heated over 100°C by using an induction heater. Additionally, the bearings should not be heated by the oil bath method.

- › The bearings should not be used under conditions involving liquid degreasing agents such as organic solvents that can affect Molded-Oil. The bearings also should not be used under conditions involving corrosive liquids or gases that can damage the parts of the bearing.

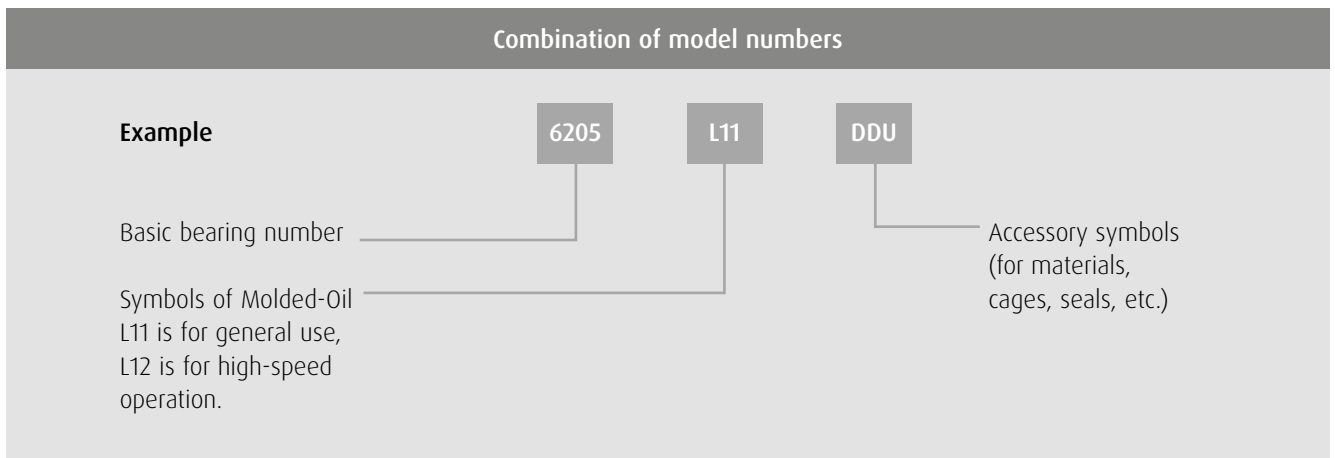

Samples of model numbers

Bearing types	Molded-Oil types	Model numbers	Remarks
Spherical roller bearings	● For general use	22311L11CAM	Machined brass cage
	● For high-speed operation	22311L11EA	Pressed steel cage
Deep groove ball bearings	● For general use	22311L12CAM	Machined brass cage
	● For high-speed operation	6205L11DDU	-
Tapered roller bearings	● For general use	6001L11-H-20DDU	Stainless-steel bearing
	● For high-speed operation	6205L12DDU	-
	● For general use	HR32024XJL11	-

Spherical roller bearings



Bearing numbers	Boundary dimensions (mm)				Basic load ratings (N)		Molded-Oil Type*
	Bore diameter	Outside diameter	Width (min.)	Chamfer dimension (min.)	C _r	C _{0r}	
21307L12CAM	35	80	21	1.5	71,000	76,000	●
21308L11ACAM	40	90	23	1.5	82,000	93,000	●
22308L11CAM	40	90	33	1.5	122,000	129,000	●
22209L11CAM	45	85	23	1.1	78,000	88,000	●
22309L12CAM	45	100	36	1.5	148,000	167,000	●
22210L11CAM	50	90	23	1.1	82,000	93,000	●
22311L12CAM	55	120	43	2.0	209,000	241,000	●
22212L12CAM	60	110	28	1.5	127,000	154,000	●
22213L11CAM	65	120	31	1.5	152,000	190,000	●
22313L11CAM	65	140	48	2.1	265,000	315,000	●
22313L12CAM	65	140	48	2.1	265,000	315,000	●
22214L11CAM	70	125	31	1.5	163,000	205,000	●
22315L12CAM	75	160	55	2.1	340,000	415,000	●
22216L11CAM	80	140	33	2.0	181,000	232,000	●
22217L12CAM	85	150	36	2.0	215,000	276,000	●
22218L12CAM	90	160	40	2.0	256,000	340,000	●
22219L12CAM	95	170	43	2.1	296,000	395,000	●
23120L11CAM	100	165	52	2.0	345,000	530,000	●
22320L11CAM	100	215	73	3.0	600,000	785,000	●
22222L12CAM	110	200	53	2.1	425,000	585,000	●
23024L11CAM	120	180	46	2.0	315,000	525,000	●
23124L12CAM	120	200	62	2.0	465,000	720,000	●
22226L11CAM	130	230	64	3.0	565,000	815,000	●
23932L11CAM	160	220	45	2.0	360,000	675,000	●

* ● = For general use, ● = For high-speed operation

Deep groove ball bearings

Bearing Steel



Bearing numbers			Boundary dimensions (mm)				Basic load ratings (N)		Molded-Oil Type*
	Shielded type	Sealed type	Bore diameter	Outside diameter	Width (min.)	Chamfer dimension (min.)	C _r	C _{0r}	
6900L11	ZZ1	DD1	10	22	6	0.3	2,700	1,270	●
6000L11	ZZ	DD	10	26	8	0.3	4,550	1,970	●
6200L11	ZZ	DDU	10	30	9	0.6	5,100	2,390	●
6901L11	ZZ2	DD1	12	24	6	0.3	2,890	1,460	●
6001L11	ZZ	DDU	12	28	8	0.3	5,100	2,370	●
6201L11	ZZ	DDU	12	32	10	0.6	6,800	3,050	●
6902L11	ZZ1	DD1	15	28	7	0.3	4,350	2,260	●
6002L11	ZZ	DDU	15	32	9	0.3	5,600	2,830	●
6202L11	ZZ	DDU	15	35	11	0.6	7,650	3,750	●
6903L11	ZZ	DDU	17	30	7	0.3	4,600	2,550	●
6003L11	ZZ	DDU	17	35	10	0.3	6,000	3,250	●
6203L11	ZZ	DDU	17	40	12	0.6	9,550	4,800	●
6904L11	ZZ	DDU	20	37	9	0.3	6,400	3,700	●
6004L11	ZZ	DDU	20	42	12	0.6	9,400	5,000	●
6204L11	ZZ	DDU	20	47	14	1.0	12,800	6,600	●
6905L11	ZZ	DDU	25	42	9	0.3	7,050	4,550	●
6005L11	ZZ	DDU	25	47	12	0.6	10,100	5,850	●
6205L11	ZZ	DDU	25	52	15	1.0	14,000	7,850	●
6906L11	ZZ	DDU	30	47	9	0.3	7,250	5,000	●
6006L11	ZZ	DDU	30	55	13	1.0	13,200	8,300	●
6206L11	ZZ	DDU	30	62	16	1.0	19,500	11,300	●
6907L11	ZZ	DDU	35	55	10	0.6	10,600	7,250	●
6007L11	ZZ	DDU	35	62	14	1.0	16,000	10,300	●
6207L11	ZZ	DDU	35	72	17	1.1	25,700	15,300	●
6908L11	ZZ	DDU	40	62	12	0.6	13,700	10,000	●
6008L11	ZZ	DDU	40	68	15	1.0	16,800	11,500	●
6208L11	ZZ	DDU	40	80	18	1.1	29,100	17,900	●
6909L11	ZZ	DDU	45	68	12	0.6	14,100	10,900	●
6009L11	ZZ	DDU	45	75	16	1.0	20,900	15,200	●
6209L11	ZZ	DDU	45	85	19	1.1	31,500	20,400	●
6010L11	ZZ	DDU	50	80	16	1.0	21,800	16,600	●
6210L11	ZZ	DDU	50	90	20	1.1	35,000	23,200	●

* ● = For general use, ● = For high-speed operation

Note: Bearing numbers other than those given in the table can also be produced. Not applicable to deep groove ball bearing with plastic cages.

Deep groove ball bearings

Stainless Steel



Bearing numbers			Boundary dimensions (mm)				Basic load ratings (N)		Molded-Oil Type*
Shielded type	Sealed type	Bore diameter	Outside diameter	Width (min.)	Chamfer dimension (min.)	C _r	C _{0r}		
6900L11-H-20	ZZ1	DD1	10	22	6	0.3	2,290	1,020	●
6000L11-H-20	ZZ	DD	10	26	8	0.3	3,900	1,580	●
6200L11-H-20	ZZ	DDU	10	30	9	0.6	4,350	1,910	●
6901L11-H-20	ZZZ	DD1	12	24	6	0.3	2,460	1,170	●
6001L11-H-20	ZZ	DDU	12	28	8	0.3	4,350	1,890	●
6201L11-H-20	ZZ	DDU	12	32	10	0.6	5,800	2,440	●
6902L11-H-20	ZZ1	DD1	15	28	7	0.3	3,700	1,810	●
6002L11-H-20	ZZ	DDU	15	32	9	0.3	4,750	2,270	●
6202L11-H-20	ZZ	DDU	15	35	11	0.6	6,500	2,980	●
6903L11-H-20	ZZ	DDU	17	30	7	0.3	3,900	2,040	●
6003L11-H-20	ZZ	DDU	17	35	10	0.3	5,100	2,600	●
6203L11-H-20	ZZ	DDU	17	40	12	0.6	8,150	3,850	●
6904L11-H-20	ZZ	DDU	20	37	9	0.3	5,400	2,940	●
6004L11-H-20	ZZ	DDU	20	42	12	0.6	7,950	4,000	●
6204L11-H-20	ZZ	DDU	20	47	14	1.0	10,900	5,250	●
6905L11-H-20	ZZ	DDU	25	42	9	0.3	5,950	3,600	●
6005L11-H-20	ZZ	DDU	25	47	12	0.6	8,550	4,650	●
6205L11-H-20	ZZ	DDU	25	52	15	1.0	11,900	6,300	●
6906L11-H-20	ZZ	DDU	30	47	9	0.3	6,150	4,000	●
6006L11-H-20	ZZ	DDU	30	55	13	1.0	11,300	6,600	●
6206L11-H-20	ZZ	DDU	30	62	16	1.0	16,500	9,050	●
6907L11-H-20	ZZ	DDU	35	55	10	0.6	9,000	5,800	●
6007L11-H-20	ZZ	DDU	35	62	14	1.0	13,600	8,200	●
6207L11-H-20	ZZ	DDU	35	72	17	1.1	21,800	12,200	●
6908L11-H-20	ZZ	DDU	40	62	12	0.6	11,600	8,000	●
6008L11-H-20	ZZ	DDU	40	68	15	1.0	14,200	9,250	●
6208L11-H-20	ZZ	DDU	40	80	18	1.1	24,800	14,300	●
6909L11-H-20	ZZ	DDU	45	68	12	0.6	12,000	8,700	●
6009L11-H-20	ZZ	DDU	45	75	16	1.0	17,800	12,200	●
6209L11-H-20	ZZ	DDU	45	85	19	1.1	26,600	16,300	●
6910L11-H-20	ZZ	DDU	50	72	12	0.6	12,400	9,400	●
6010L11-H-20	ZZ	DDU	50	80	16	1.0	18,500	13,300	●
6210L11-H-20	ZZ	DDU	50	90	20	1.1	29,800	18,600	●

* ● = For general use, ● = For high-speed operation

Note: Bearing numbers other than those given in the table can also be produced. Not applicable to deep groove ball bearing with plastic cages.

Bearing Types and Availability

Available Molded-Oil Bearing type, cage type, limiting speed, and size (outside diameter, mm)

Bearing types	Molded-Oil types	Cage types	Limiting speeds ($d_m n$)	Sizes (outside diameter, mm)
Spherical roller bearings	● For general use (L11)	Machined brass (CA)	< 60,000	$70 \leq AD \leq 250$
		Pressed steel (EA)	< 30,000	$70 \leq AD \leq 215$
	● For high-speed operation (L12)	Machined brass (CA)	60,000 – 100,000	$70 \leq AD \leq 215$
Deep groove ball bearings	● For general use (L11)	Pressed steel	< 150,000	$19 \leq AD \leq 250$
		Pressed steel	150,000 – 200,000	$19 \leq AD \leq 215$
Tapered roller bearings	● For general use (L11)	Pressed steel	< 40,000	$80 \leq AD \leq 215$

- › $d_m n = [(\text{Bearing bore diameter, mm} + \text{Bearing outside diameter, mm}) \div 2] \times \text{inner ring rotational speed, min}^{-1}$
- › Some large spherical roller bearing numbers may not be available
- › Conditions including abutment and fillet dimensions must be taken into consideration for tapered roller bearings
- › For tapered roller bearings and spherical roller bearings with pressed steel cages (EA), Molded-Oil Bearings for high-speed operation (L12) are not available
- › For the application under the condition of low speed and low temperature, Molded-Oil Bearings for general use (L11) are recommended

Ambient temperature and limiting speed ($d_m n$)

The relation between limiting speed and ambient temperature is as follows:

a. Spherical roller bearings (CA)

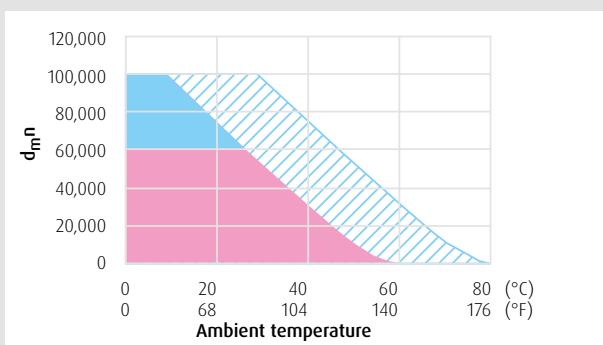

b. Spherical roller bearings (EA)

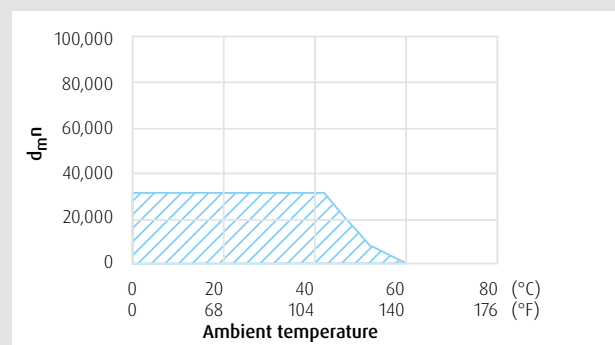

● L11 Applicable range

● L12 Applicable range

▨ L12 Intermittent operation applicable range

Ambient temperature and limiting speed ($d_{m,n}$)

The relation between limiting speed and ambient temperature is as follows:

c. Deep groove ball bearings

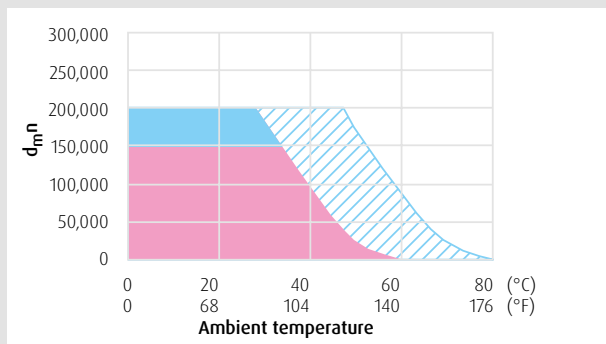

d. Tapered roller bearings

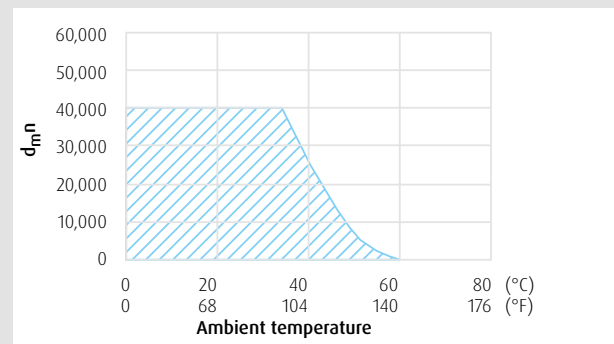

● L11 Applicable range

● L12 Applicable range

▨ L12 Intermittent operation applicable range

Limiting speeds ($d_{m,n}$) of “a” to “d” shown above are examples for general housing. If there is a source of heat near the bearings, or the cooling effect by the radiation or the heat transmission, the above limiting speed cannot be expected due to the application.

Precautions for Selecting

The following precautions should be considered to maintain the high performance of Molded-Oil Bearings:

- › For low-temperature applications, Molded-Oil Bearings for general use (L11) are recommended.
- › For the condition of high ambient temperature, Molded-Oil Bearings for high-speed operation (L12) are recommended.
- › To rotate the bearings properly, it is necessary to apply the radial load. As a standard of the radial load, more than 1% of the basic dynamic load rating is recommended.
- › Since Molded-Oil Bearings are lubricated by oil seeped from a Molded-Oil, the bearings cannot be used under the condition where the bearings are exposed to water directly for an extended period of time (the oil could be washed away). If the application requires such exposure, consider using extra seals.

Performance Test

Molded-Oil Bearings feature a number of excellent functions. Extensive test data and field results demonstrate the outstanding performance of Molded-Oil Bearings.

Durability test under conditions of exposure to water

Grease lubrication allows operation for extended periods of time even if exposed to mist or submerged in water. Continuous operation with grease lubrication: approximately 20 days; with Molded-Oil Bearings: 50 days or more. Molded-Oil Bearings can be operated for longer time than the bearings with grease lubrication even if exposed to mist or submerged in water.

Environment where exposed to water - cleaning equipment is assumed		
Test conditions	Test bearings	6000-H-DD (stainless steel with contact seal)
	Rotational speed	1,000 min ⁻¹
	Radial load	79.4 N
	Axial load	29.4 N
	Water exposure	0.8 cm ³ /min
	Spray pressure	0.2 MPa

Environment of submerged condition - under water vehicle and facilities are assumed		
Test conditions	Test bearings	6000-H-DD (stainless steel with seal)
	Rotational speed	1,000 min ⁻¹
	Radial load	79.4 N
	Axial load	29.4 N

Fig. 1 Testing device under conditions of exposure to water

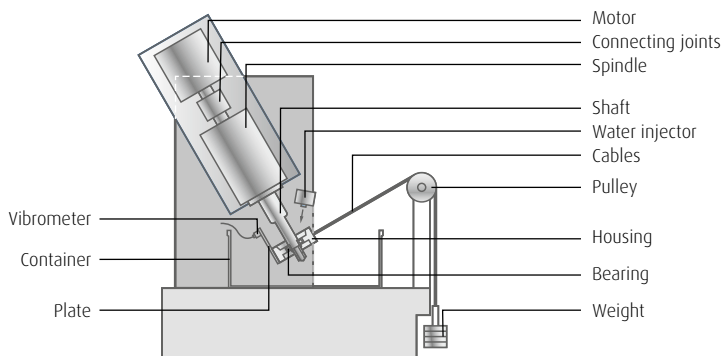

Fig. 2 Durability test results under exposing to water

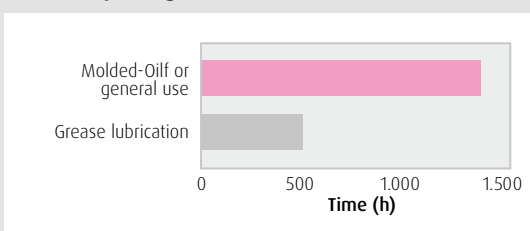
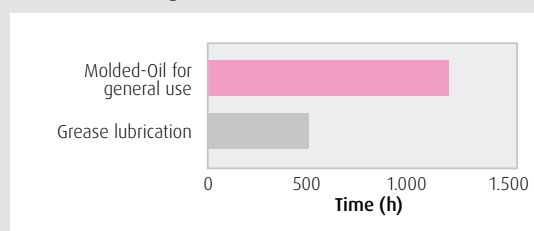

Fig. 3 Durability test results under submerged condition



Durability performance test

Slow seeping of the lubricant from Molded-Oil provides excellent lubrication performance for extended periods. Molded-Oil Bearings for general use cannot be used under conditions of high-speed rotation, but Molded-Oil Bearings for high-speed operation perform with excellent durability under such conditions.

Durability performance test			
Test conditions	Test bearings	6305DDU	
	Radial load	98 N	
	Axial load	245 N	
	Rotational speed	1	3,500 min ⁻¹ (d _m n : 152,000)
		2	4,200 min ⁻¹ (d _m n : 183,000)
3		4,600 min ⁻¹ (d _m n : 200,000)	

Fig. 4 Durability test results of deep groove ball bearings

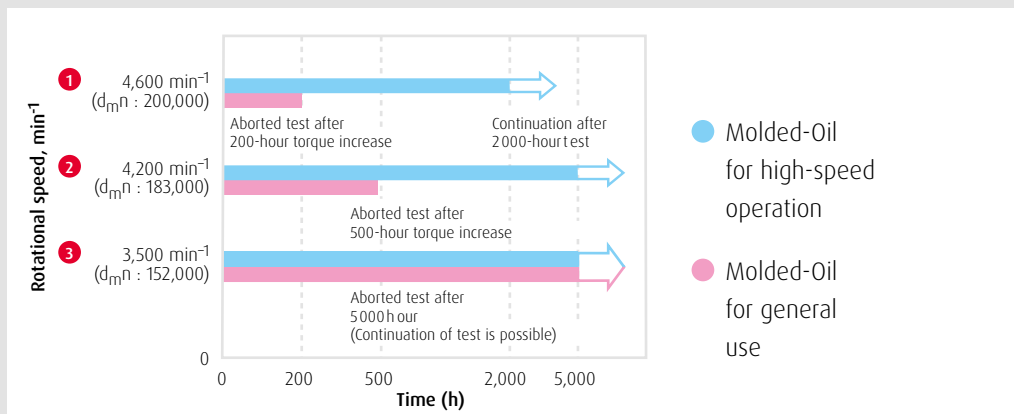
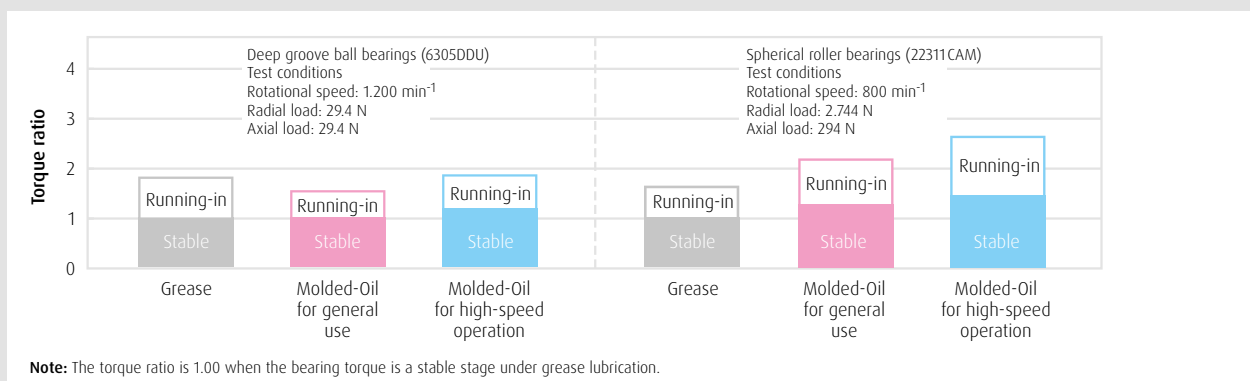

Fig. 5 Bearing torque comparison of grease-lubricated and Molded-Oil bearings





NSK AMERICAS

Argentina

NSK Argentina SRL
Buenos Aires
54.11.4762.6556

Brazil

NSK Brasil Ltda.
Sao Paulo SP
55.11.3269.4700

Canada

NSK Canada Inc.
Mississauga ON
1.877.994.6675

Latin America

NSK Latin America Inc.
Miami FL
1.305.477.0605

Mexico

NSK Rodamientos Mexicana, S.A. de C.V.
Tlaineantla de Baz MX
52.55.3682.2900

United States

NSK Corporation
Ann Arbor MI
1.888.446.5675

Website: www.nskamericas.com

NSK Global: www.nsk.com

Every care has been taken to ensure the accuracy of the data contained in this brochure, but no liability can be accepted for any loss or damage suffered through errors or omissions.

Printed in Germany ©NSK 2014. The contents of this publication are the copyright of the publishers.