

NSK

NSK LINEAR GUIDES NH SERIES, NS SERIES



STAY IN MOTION. STAY IN CONTROL.

WITH STATE-OF-THE-ART TECHNOLOGY, THE STANDARD IN NSK LINEAR GUIDES™ HAS BEEN REBORN.

FEATURES OF NH AND NS SERIES

1. Excellent durability

Super-long life, twice as long compared to conventional series

NH and NS series have a load rating 1.3 times greater and a lifespan two times longer than LH and LS Series*1. These features enable you to design a machine with a longer life and/or downsize the machine.

*1: Based on the representative values of each series.

Maintenance-free

Installing NSK K1™ lubrication unit (optional) ensures a long-term, maintenance-free operation, saving cost. Environmental protection can also be achieved.

What is "NSK K1™" lubrication unit?

NSK K1™ is a lubrication device which combines oil and resin in a single unit. The porous resin contains a large amount of lubrication oil. As the linear guide operates, the NSK K1™ provides fresh oil to the contacting surfaces.

2. Easy-to-use "Standard Linear Guides"

Random-matching (interchangeable) type is available

The rails and ball slides can be selected in many combinations. All NH/NS models can be interchanged with LH and LS Series, respectively. Free combination of different ball slide types, accuracy grades, and preload can be made.

Robust design to absorb mounting errors

The DF combination results in a high self-aligning capability. This increases the capacity to absorb errors in installation, and will demand less work to achieve precision in mounting the linear guide.

Fig. 1

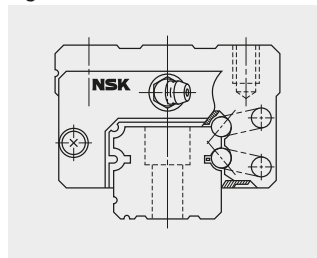

Options

Accessory options are available, including NSK K1™ lubrication units, double seals, protectors, surface treatments, etc.

Mounting dimensions are the same as the LH and LS Series

NH and NS are completely interchangeable with LH and LS and can be used without making any design modifications.

NH Series

Larger load rating capacity



NS Series

Compact, low-profile shape

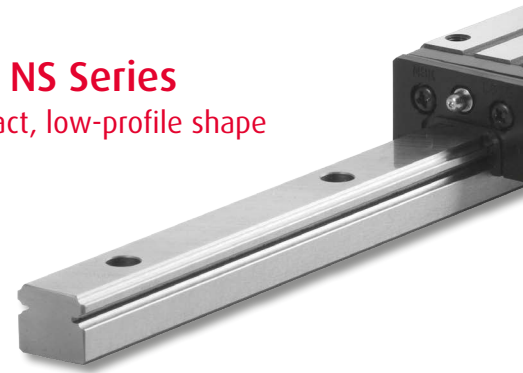

By mounting a NSK K1™ lubrication unit (optional), a long-term, maintenance-free operation can be achieved.





Produced through state-of-the-art technology

Based on the LH/LS Series, which have achieved exceptional results in numerous application areas since their debut in 1989, the new NH/NS Series are created as the focal point of NSK's cumulated state-of-the-art design and manufacturing technologies.

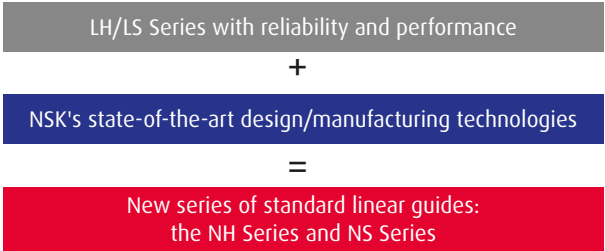

Ball groove geometry contributing to long life

New ball groove geometry is introduced, which has been developed by utilizing NSK's state-of-the-art tribological and analytical technologies. Due to the optimized distribution of contact surface pressure, the rating life has dramatically increased. As compared with the LH/LS Series, the load rating capacity of the new series has increased 1.3 times, while the life span has increased two times*1.

*1: Representative values of each series.

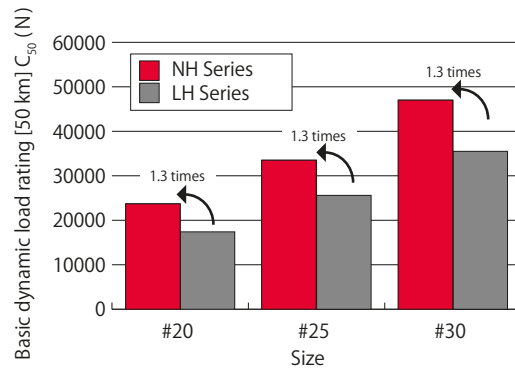

Ball circulating groove with excellent high-speed capability

By re-examining the design for the ball circulation path, we have attained smoother ball circulation and a reduced noise level. The new NH/NS series are well suited for high-speed applications.

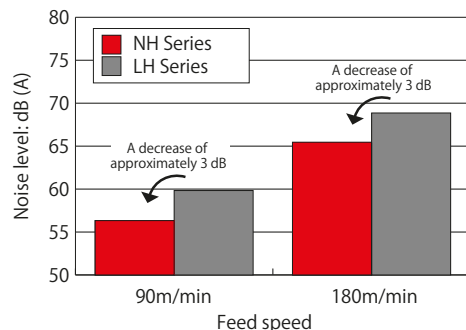

*Measurement results are obtained from the size #25 linear guide alone.
Microphone position: 500 mm above the top of the sample.
The noise level varies depending on the microphone position.

SPECIFICATIONS

1. Ball Slide Shape

- › Two types of ball slides are available: square type with tapped holes and mounting flange type.
- › A compact, square type, low-profile model is also available.
- › On the mounting holes of the flange type, the tapped part is used to fix the ball slide from the top surface, while the minor diameter can be used as a bolt hole for mounting from the bottom. This enables mounting from either direction, top or bottom.
- › The ball slide length is available in three lengths: standard high-load, long super-high load or short medium-load. The available ball slide length differs depending on the type. Please refer to the dimension table.

Fig. 2 Ball slide shape

BALL SLIDE SHAPE	SHAPE/INSTALLATION METHOD	TYPE (UPPER ROW: RATING; LOWER ROW: BALL SLIDE LENGTH)		
		HIGH-LOAD TYPE	SUPER-HIGH-LOAD TYPE	MEDIUM-LOAD TYPE
		STANDARD	LONG	SHORT
AN BN		AN 	BN 	
AL BL CL		AL 	BL 	CL
EM GM JM		EM 	GM 	JM

2. Maximum Rail Length

- › Table 1 shows the limitations of rail length (maximum length).
- › Depending on the required accuracy grade, the available maximum rail length might be shorter than that shown in Table 1.

Table 1 Length limitations of rails

Unit: mm

SERIES	MATERIAL	SIZE	15	20	25	30	35	45	55	65
NH	Special high carbon steel		2 980	3 960	3 960	4 000	4 000	3 990	3 960	3 900
	Stainless steel		1 800	3 500	3 500	3 500				
NS	Special high carbon steel		2 920	3 960	3 960	4 000	4 000			
	Stainless steel		1 700	3 500	3 500	3 500	3 500			

Note: Rails can be butted if user requirement exceeds the rail length shown in the table. Please consult NSK.

3. Accuracy

- › The setting of the accuracy grade differs depending on whether the required type is of the preloaded assembly or the interchangeable type.
- › For the preloaded assembly, different accuracy grades are available: Ultra precision P3, Super precision P4, High precision P5, Precision P6, and Normal PN grades.
- › The interchangeable type has High Precision PH and Normal PC grade.

Table 2 Tolerance of preloaded assembly

Unit: μm

CHARACTERISTICS	ACCURACY GRADE	ULTRA PRECISION P3	SUPER PRECISION P4	HIGH PRECISION P5	PRECISION GRADE P6	NORMAL GRADE PN
Mounting height H Variation of H (All ball slides on a set of rails)		± 10 3	± 10 5	± 20 7	± 40 15	± 80 25
Mounting width W_2 or W_3 Variation of W_2 or W_3 (All ball slides on reference rail)		± 15 3	± 15 7	± 25 10	± 50 20	± 100 30
Running parallelism of surface C to surface A Running parallelism of surface D to surface B		Refer to Fig. 3 and Table 4.				

Table 3 Tolerance of interchangeable type

Unit: μm

CHARACTERISTICS	ACCURACY GRADE	HIGH PRECISION GRADE PH		NORMAL GRADE PC	
	MODEL NO.	NH15,20,25,30,35 NS15,20,25,30,35	NH45,55,65	NH15,20,25,30,35 NS15,20,25,30,35	NH45,55,65
Mounting height H		± 20	± 30	± 20	± 30
Variation of mounting height H		15	20	15	20
Mounting width W_2 or W_3		± 30	± 35	± 30	± 35
Variation of mounting width W_2 or W_3		20	20	25	30
Running parallelism of surface C to surface A Running parallelism of surface D to surface B		Refer to Fig. 3 and Table 4.			

Note: Variation in the interchangeable products means the variation among the values taken at the same position on the same rail.

Table 4 Running parallelism of ball slide

Unit: μm

RAIL LENGTH (MM)	PRELOAD ASSEMBLY					INTERCHANGEABLE TYPE	
	ULTRA PRECISION P3	SUPER PRECISION P4	HIGH PRECISION P5	PRECISION GRADE P6	NORMAL GRADE PN	HIGH PRECISION PH	NORMAL GRADE PC
Over ~ 50 or less	2	2	2	4.5	6	2	6
50 ~ 80	2	2	3	5	6	3	6
80 ~ 125	2	2	3.5	5.5	6.5	3.5	6.5
125 ~ 200	2	2	4	6	7	4	7
200 ~ 250	2	2.5	5	7	8	5	8
250 ~ 315	2	2.5	5	8	9	5	9
315 ~ 400	2	3	6	9	11	6	11
400 ~ 500	2	3	6	10	12	6	12
500 ~ 630	2	3.5	7	12	14	7	14
630 ~ 800	2	4.5	8	14	16	8	16
800 ~ 1 000	2.5	5	9	16	18	9	18
1 000 ~ 1 250	3	6	10	17	20	10	20
1 250 ~ 1 600	4	7	11	19	23	11	23
1 600 ~ 2 000	4.5	8	13	21	26	13	26
2 000 ~ 2 500	5	10	15	22	29	15	29
2 500 ~ 3 150	6	11	17	25	32	17	32
3 150 ~ 4 000	9	16	23	30	34	23	34

Fig. 3 Specifications of accuracy

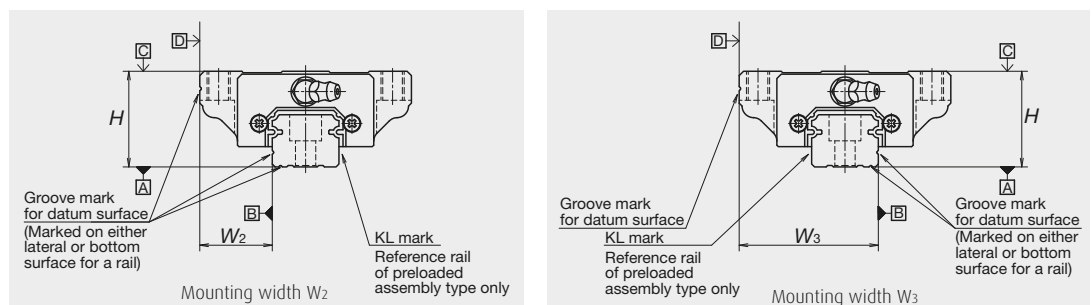

SPECIFICATIONS (CONT)

4. Preload and Rigidity

- › Preload setting differs between the preloaded assembly and interchangeable types.
- › For the preloaded assembly, Medium preload Z3, Slight preload Z1 and Fine clearance Z0 are available.
- › For the interchangeable type, Medium preload ZH, Slight preload ZZ and Fine clearance ZT are available.
- › Possible combinations between the accuracy and preload grades are shown in Table 9.

Table 5 Preload and rigidity of preloaded assembly - NH Series

MODEL NO.	PRELOAD (N)		RIGIDITY (N/μm)			
	SLIGHT PRELOAD Z1	MEDIUM PRELOAD Z3	VERTICAL DIRECTION		LATERAL DIRECTION	
			SLIGHT PRELOAD Z1	MEDIUM PRELOAD Z3	SLIGHT PRELOAD Z1	MEDIUM PRELOAD Z3
NH15 AN, EM	78	490	137	226	98	186
NH20 AN, EM	147	835	186	335	137	245
NH25 AL, AN, EM	196	1 270	206	380	147	284
NH30 AL, AN	245	1 570	216	400	157	294
NH30 EM	294	1 770	265	480	186	355
NH35 AL, AN, EM	390	2 350	305	560	216	390
NH45 AL, AN, EM	635	3 900	400	745	284	540
NH55 AL, AN, EM	980	5 900	490	910	345	645
NH65 AN, EM	1 470	8 900	580	1 070	400	755
NH15 BN, GM	98	685	196	345	137	284
NH20 BN, GM	196	1 080	265	480	196	355
NH25 BL, BN, GM	245	1 570	294	560	216	400
NH30 BL, BN, GM	390	2 260	360	665	265	480
NH35 BL, BN, GM	490	2 940	430	795	305	570
NH45 BL, BN, GM	785	4 800	520	960	370	695
NH55 BL, BN, GM	1 180	7 050	635	1 170	440	835
NH65 BN, GM	1 860	11 300	805	1 480	550	1 040

Note: Clearance for Fine clearance Z0 is 0 to 3 μm, Therefore, preload is zero. However, Z0 of PN grade is 0 to 15 μm.

Table 7 Preload and rigidity of preloaded assembly - NS Series

MODEL NO.	PRELOAD (N)		RIGIDITY (N/μm)			
	SLIGHT PRELOAD Z1	MEDIUM PRELOAD Z3	VERTICAL DIRECTION		LATERAL DIRECTION	
			SLIGHT PRELOAD Z1	MEDIUM PRELOAD Z3	SLIGHT PRELOAD Z1	MEDIUM PRELOAD Z3
NS15 AL, EM	69	390	127	226	88	167
NS20 AL, EM	88	540	147	284	108	206
NS25 AL, EM	147	880	206	370	147	275
NS30 AL, EM	245	1 370	255	460	186	345
NS35 AL, EM	345	1 960	305	550	216	400
NS15 CL, JM	49	294	78	147	59	108
NS20 CL, JM	69	390	108	186	78	137
NS25 CL, JM	98	635	127	235	88	177
NS30 CL, JM	147	980	147	275	108	206
NS35 CL, JM	245	1 370	186	335	137	245

Note: Clearance for Fine clearance Z0 is 0 to 3 μm, Therefore, preload is zero. However, Z0 of PN grade is 0 to 15 μm.

Table 9 Combinations of accuracy and preload

		ACCURACY GRADE						
		ULTRA PRECISION	SUPER PRECISION	HIGH PRECISION	PRECISION GRADE	NORMAL GRADE	HIGH PRECISION	NORMAL GRADE
WITHOUT NSK K1™ LUBRICATION UNIT		P3	P4	P5	P6	PN	PH	PC
WITH NSK K1™ LUBRICATION UNIT		K3	K4	K5	K6	KN	KH	KC
WITH NSK K1™ FOR FOOD AND MEDICAL EQUIPMENT		F3	F4	F5	F6	FN	FH	FC
PRELOAD	Fine clearance Z0	■	■	■	■	■		
	Slight preload Z1	■	■	■	■	■		
	Medium preload Z3	■	■	■	■			
	Interchangeable type with fine clearance ZT							■
	Interchangeable type with slight preload ZZ						■	■
	Interchangeable type with medium preload ZH						■	■

Table 6 Clearance and preload of interchangeable type - NH Series Unit: μm

MODEL NO.	FINE CLEARANCE ZT	SLIGHT PRELOAD ZZ	MEDIUM PRELOAD ZH
NH15	-4 ~ 15	-4 ~ 0	-3 ~ -7
NH20	-5 ~ 15	-5 ~ 0	-3 ~ -8
NH25		-5 ~ 0	-4 ~ -9
NH30		-7 ~ 0	-5 ~ -12
NH35		-7 ~ 0	-5 ~ -12
NH45		-7 ~ 0	-7 ~ -14
NH55		-9 ~ 0	-9 ~ -18
NH65		-9 ~ 0	-10 ~ -19

Note: Minus sign denotes the value is an amount of preload (elastic deformation of balls).

Table 8 Clearance and preload of interchangeable type - NS Series Unit: μm

MODEL NO.	FINE CLEARANCE ZT	SLIGHT PRELOAD ZZ	MEDIUM PRELOAD ZH
NS15	-4 ~ 15	-4 ~ 0	-3 ~ -7
NS20	-4 ~ 15	-4 ~ 0	-3 ~ -7
NS25	-5 ~ 15	-5 ~ 0	-4 ~ -9
NS30	-5 ~ 15	-5 ~ 0	-4 ~ -9
NS35	-5 ~ 15	-6 ~ 0	-4 ~ -10

Note: Minus sign denotes the value is an amount of preload (elastic deformation of balls).

5. Basic Load Rating and Rating Life

The basic load rating used for expressing the load capacity of the linear guide is determined by ISO standards (ISO14728-1, 14728-2). The load rating applied to NSK Linear Guides complies with the ISO standards. The basic dynamic load rating is the non-fluctuating load which acts on the center of the ball slide from above, and under which the rating fatigue life of 100 km or 50 km is expressed. When load F is only applied to the ball slide in the up/down direction, its rating fatigue life, L can be calculated using the following equation, where C_{100} means a basic dynamic load rating for 100 km rating fatigue life and C_{50} means a basic dynamic load rating for 50 km rating fatigue life respectively.

The basic static load rating is the static load which generates a contact stress of 4 200 MPa at the center of the contact area between the rolling element subjected to the maximum stress and the raceway surface. In this most heavily stressed contact area, the sum of the permanent deformation of the rolling element and that of the raceway is nearly 0.0001 times the rolling element's diameter.

The basic load rating values are written in the dimension table. In NH and NS series, the contact angle is set at 50 degrees increasing the load carrying capacity in the vertical direction. Each basic load rating in the down, up and lateral load direction is shown at Table 11.

- Please note that the equation used here for calculating the product life is different from the one used for the linear guides for which rollers are used as rolling elements.
- The load factor is expressed as "fw". Select the best-suited load factor, referring to the values given in Table 10, according to the potential vibration or impact loads in the machine onto which the linear guide is to be mounted.

$$L = 100 \times \left(\frac{C_{100}}{fw \cdot F} \right)^3 \quad \text{or} \quad L = 50 \times \left(\frac{C_{50}}{fw \cdot F} \right)^3 \quad [\text{km}]$$

The loads applied to the linear guide (i.e., ball slide loads) range from loads in the up/down or right/left direction to moment loads. Sometimes, more than one type of load is applied simultaneously or the volume and direction of the load may vary.

Varying loads cannot be used for the life calculation of the linear guide as they are. Therefore, it is necessary to use a hypothetical constant load applied to the ball slide, which would generate a fatigue life equivalent to the actual fatigue life. This is called the dynamic equivalent load. To calculate the dynamic equivalent load, use the loads provided in Table 12.

Table 12 Loads in the arrangement of linear guides

PATTERN	ARRANGEMENT OF LINEAR GUIDE	LOADS NECESSARY TO CALCULATE DYNAMIC EQUIVALENT LOAD					DYNAMIC EQUIVALENT LOAD
		LOAD		MOMENT LOAD			
		UP/DOWN (VERTICAL)	RIGHT/LEFT (LATERAL)	ROLLING	PITCHING	YAWING	
1		F_r	F_s	M_r	M_p	M_y	$F_r = F_r$ $F_{se} = F_s \cdot \tan \alpha$ $F_{re} = \epsilon_r \cdot M_r$ $F_{pe} = \epsilon_p \cdot M_p$ $F_{ye} = \epsilon_y \cdot M_y$ α : Contact angle ($\approx 50^\circ$) Dynamic equivalent coefficients ϵ_r : Rolling direction ϵ_p : Pitching direction ϵ_y : Yawing direction
2		F_r	F_s	M_r			
3		F_r	F_s		M_p	M_y	
4		F_r	F_s				

The formula is determined by the relationship of loads in terms of volume. A full dynamic equivalent load can be easily obtained by using each coefficient.

After obtaining the dynamic equivalent load of the necessary load direction from Table 13, use the formulas below to calculate full dynamic equivalent loads.

· When F_r is the largest load: $F_e = F_r + 0.5F_{se} + 0.5F_{re} + 0.5F_{pe} + 0.5F_{ye}$

· When F_{se} is the largest load: $F_e = 0.5F_r + F_{se} + 0.5F_{re} + 0.5F_{pe} + 0.5F_{ye}$

· When F_{re} is the largest load: $F_e = 0.5F_r + 0.5F_{se} + F_{re} + 0.5F_{pe} + 0.5F_{ye}$

· When F_{pe} is the largest load: $F_e = 0.5F_r + 0.5F_{se} + 0.5F_{re} + F_{pe} + 0.5F_{ye}$

· When F_{ye} is the largest load: $F_e = 0.5F_r + 0.5F_{se} + 0.5F_{re} + 0.5F_{pe} + F_{ye}$

For the values of each dynamic equivalent load in the formulas above, disregard load directions and take the absolute value.

Table 10 Load factor fw

IMPACT/VIBRATION	LOAD FACTOR
No external impact/vibration	1.0 ~ 1.5
There is impact/vibration from outside.	1.5 ~ 2.0
There is significant impact/vibration.	2.0 ~ 3.0

Table 11 Basic load rating by load direction

LOAD RATING	DIRECTION	DOWNWARD	UPWARD	LATERAL
Basic dynamic load rating		C	C	0.84C
Basic static load rating		C_0	$0.78C_0$	$0.65C_0$

Fig. 4 Load directions

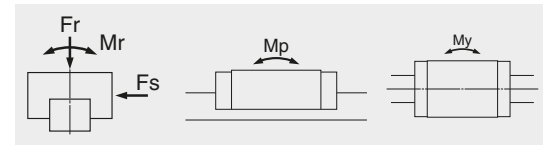

Table 13 Dynamic equivalent coefficients

MODEL	DYNAMIC EQUIVALENT COEFFICIENTS (1/M)		
	ϵ_r	ϵ_p	ϵ_y
NH15AN, EM	188	111	132
NH15BN, GM	188	72	86
NH20AN, EM	142	81	97
NH20BN, GM	142	57	68
NH25AL, AN, EM	123	68	81
NH25BL, BN, GM	123	51	61
NH30AL, AN	98	70	83
NH30EM	98	58	69
NH30BL, BN, GM	98	44	52
NH35AL, AN, EM	78	51	61
NH35BL, BN, GM	78	36	43
NH45AL, AN, EM	60	38	45
NH45BL, BN, GM	60	30	36
NH55AL, AN, EM	51	31	37
NH55BL, BN, GM	51	25	30
NH65AN, EM	43	27	32
NH65BN, GM	43	20	24
NS15AL, EM	177	116	138
NS15CL, JM	177	174	208
NS20AL, EM	127	94	112
NS20CL, JM	127	136	162
NS25AL, EM	111	70	83
NS25CL, JM	111	108	129
NS30AL, EM	94	63	75
NS30CL, JM	94	102	121
NS35AL, EM	76	54	64
NS35CL, JM	76	87	104

SPECIFICATIONS (CONT)

6. Dust-proof parts and Lubrication accessories

(1) Standard specification

- Standard specification can be readily used as they have a dust protection means for normal conditions. As standard equipment, the ball slides have end seals and bottom seals.
- Dust-proof parts are available, as shown in Table 14. Select the best-suited one according to the environment.

Table 14 Optional dust-proof parts

NAME	PURPOSE
NSK K1™ lubrication unit	Made of oil impregnated resin. Enhances lubricating functions.
Double seal	It combines two end seals for enhancing sealing function.
Protector	Protect the end seal from hot and hard contaminants.
Rail cap	Prevents foreign matters generated in cutting operation from clogging the rail-mounting holes.
Inner seal	Installed inside a slide, and prevents foreign matters from entering the rolling contact surface.
Bellows	Covers the linear guide.

Note: Inner seals can be selected for NH20-65 and NS20-35.

(2) Mounting position of the lubrication accessories

- The standard position of grease fittings is the end face of ball slide. We mount them on a side of end cap for an option. (Fig. 6).
- Please consult NSK for installation of grease or tube fittings to the ball slide body or side of end cap.

(3) NSK K1™ Lubrication unit

Table 15 shows the dimensions of the linear guides equipped with the NSK K1™ lubrication unit.

Fig. 7

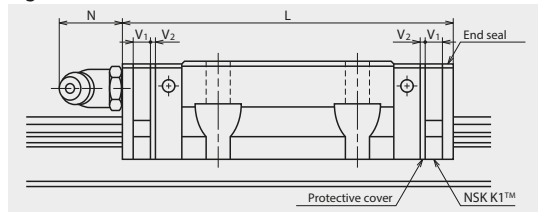

7. Rust Prevention

(1) Stainless steel

Stainless steel material can be selected for the parts made of carbon steel. The models which can be made with stainless steel are NH15-30 and NS15-35. However, the high precision (PH) grade and the medium preload (ZH) type of the interchangeable type can not be made from stainless steel.

(2) Surface treatment

Regarding surface treatment, NSK recommends low temperature chrome plating or fluoride low temperature chrome plating. Please consult NSK for other surface treatment.

Table 16 Material/surface treatment code

CODE	DESCRIPTION
C	Special high carbon steel (NSK standard)
S	Stainless steel
D	Special high carbon steel with surface treatment
H	Stainless steel with surface treatment
Z	Other, special

Fig. 5

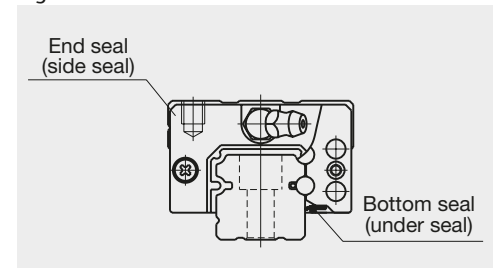

Fig. 6 Mounting position of lubrication accessories

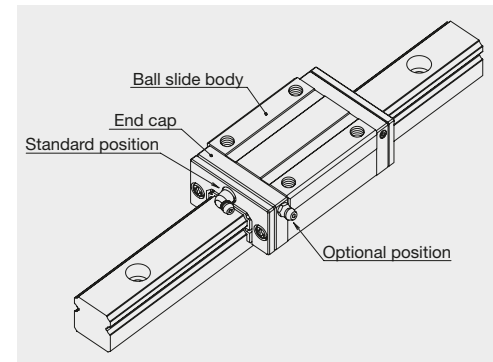

Table 15

Unit: mm

MODEL NO.	STANDARD BALL SLIDE LENGTH	BALL SLIDE LENGTH INSTALLED WITH TWO NSK K1™ L	PER NSK K1™ THICKNESS V ₁	PROTECTIVE COVER THICKNESS V ₂	PROTRUDING AREA OF THE GREASE FITTING N	
NH15	AN, EM	55	65.6	4.5	0.8	(5)
	BN, GM	74	84.6			
NH20	AN, EM	69.8	80.4	4.5	0.8	(14)
	BN, GM	91.8	102.4			
NH25	AL, AN, EM	79	90.6	5	0.8	(14)
	BL, BN, GM	107	118.6			
NH30	AL, AN	85.6	97.6	5	1	(14)
	EM	98.6	110.6			
NH35	BL, BN, GM	124.6	136.6	5.5	1	(14)
	AL, AN, EM	109	122			
NH45	BL, BN, GM	143	156	6.5	1	(15)
	AL, AN, EM	139	154			
NH55	BL, BN, GM	171	186	6.5	1	(15)
	AL, AN, EM	163	178			
NH65	BL, BN, GM	201	216	8	1	(16)
	AN, EM	193	211			
NS15	BL, BN, GM	253	271	4	0.8	(5)
	AL, EM	56.8	66.4			
NS20	CL, JM	40.4	50	4.5	0.8	(14)
	AL, EM	65.2	75.8			
NS25	CL, JM	47.2	57.8	4.5	0.8	(14)
	AL, EM	81.6	92.2			
NS30	CL, JM	59.6	70.2	5	1	(14)
	AL, EM	96.4	108.4			
NS35	CL, JM	67.4	79.4	5.5	1	(14)
	AL, EM	108	121			
	CL, JM	77	90			

Notes:

- NSK K1™ for food and medical equipments are available for NH15-35 and NS15-35.
- Ball slide length equipped with NSK K1™ = (Standard ball slide length) + (Thickness of NSK K1™, V₁ x Number of NSK K1™) + (Thickness of the protective cover, V₂ x 2)

8. Installation

(1) Permissible values of mounting error

Mounting errors may result in harmful effects, such as shortened operating life, deteriorated motion accuracy and/or friction variation. Using those mounting errors shown in Figures 8 and 9 as representative errors, Tables 17 and 18 show the mounting tolerances.

Fig. 8

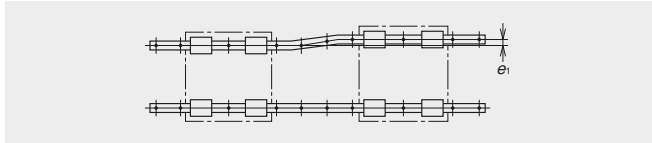

Fig. 9

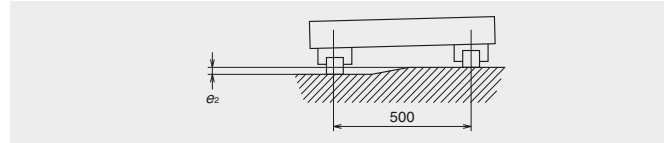

Table 17

Unit: μm

VALUE	PRELOAD	MODEL NO.							
		NH15	NH20	NH25	NH30	NH35	NH45	NH55	NH65
Permissible values of parallelism in two rails e_1	Z0, ZT	22	30	40	45	55	65	80	110
	Z1, ZZ	18	20	25	30	35	45	55	70
	Z3, ZH	13	15	20	25	30	40	45	60
Permissible values of parallelism(height) in two rails e_2	Z0, ZT	375 μm /500mm							
	Z1, ZZ, Z3, ZH	330 μm /500mm							

Table 18

Unit: μm

VALUE	PRELOAD	MODEL NO.				
		NS15	NS20	NS25	NS30	NS35
Permissible values of parallelism in two rails e_1	Z0, ZT	20	22	30	35	40
	Z1, ZZ	15	17	20	25	30
	Z3, ZH	12	15	15	20	25
Permissible values of parallelism(height) in two rails e_2	Z0, ZT	375 μm /500mm				
	Z1, ZZ, Z3, ZH	330 μm /500mm				

(2) Shoulder height and corner radius of the mounting surface

When horizontally fixing a rail or ball slide by pushing it to the shoulder (the riser portion of the mounting surface) of the bed or table, refer to the shoulder height and corner radius specified in Fig. 10 and 11 and Table 19 as well.

Shoulder height of the mounting surface and corner radius r

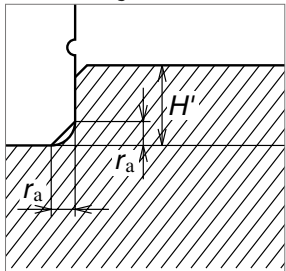

Fig. 10 Shoulder for the rail datum surface

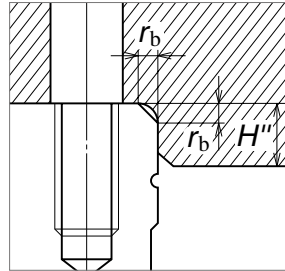

Fig. 11 Shoulder for the ball slide datum surface

Table 19

Unit: mm

MODEL NO.	CORNER RADIUS (MAXIMUM)		SHOULDER HEIGHT	
	R_A	R_B	H'	H''
NH15	0.5	0.5	4	4
NH20	0.5	0.5	4.5	5
NH25	0.5	0.5	5	5
NH30	0.5	0.5	6	6
NH35	0.5	0.5	6	6
NH45	0.7	0.7	8	8
NH55	0.7	0.7	10	10
NH65	1.0	1.0	11	11
NS15	0.5	0.5	4	4
NS20	0.5	0.5	4.5	5
NS25	0.5	0.5	5	5
NS30	0.5	0.5	6	6
NS35	0.5	0.5	6	6

9. Maximum allowable speed

An indication of the standard maximum allowable speed aiming at 10,000km operation with linear guide under normal conditions is shown in Table 20. However, the maximum allowable speed can be affected by accuracy of installation, operating temperature, external load, etc. If the operation is made exceeding the permissible distance and speed, please contact NSK.

Table 20 Maximum Allowable Speed

Unit: m/min

SIZE	15	20	25	30	35	45	55	65
NH			300				200	150
NS			300				—	—

10. Handling Precautions

- Beating a slide or hitting it against an object may cause damage.
- Operating temperature should be less than 80°C. If exceeding this temperature, the plastic parts might be damaged.
- If using NSK K1™, maximum temperature in use: 50°C (momentary maximum temperature in use: 80°C). Do not leave NSK K1™ lubrication unit in organic solvent, white kerosene such as hexane, thinner which removes oil, and rust prevention oil which contains white kerosene.
- Regarding the handling of interchangeable products.
 - Slides of interchangeable type are assembled on a provisional rail (an inserting tool) when it is delivered.
 - When a slide is installed to the rail, make certain to use a provisional rail.
 - Do not remove slides from the provisional rail, except installation to the rail.

DIMENSIONS

NH-AN (HIGH-LOAD TYPE/STANDARD, SQUARE TYPE) NH-BN (SUPER-HIGH-LOAD TYPE/LONG, SQUARE TYPE)

(1) Reference number for assembly

NH	30	1200	AN	C	2		P5	3
SERIES NAME	SIZE	RAIL LENGTH (MM)	BALL SLIDE SHAPE CODE (refer to Fig 2 on page 4)	MATERIAL/SURFACE TREATMENT CODE (refer to Table 16 on page 8) C: Special high carbon steel (NSK standard) S: Stainless steel	NUMBER OF BALL SLIDES PER RAIL	DESIGN SERIAL NUMBER (Added to the reference number)	ACCURACY CODE (refer to page 5 and 6)	PRELOAD CODE (refer to page 6) 0: Z0 1: Z1 3: Z3 T: ZT Z: ZZ H: ZH

(2) Reference number for interchangeable type

Ball slide

NAH	30	AN	S	Z	-K
INTERCHANGEABLE BALL SLIDE SERIES CODE NAH: NH Series Interchangeable Ball Slide	SIZE	BALL SLIDE SHAPE CODE (refer to Fig 2 on page 4)	MATERIAL CODE No code: Special high carbon steel (NSK standard) S: Stainless steel	PRELOAD CODE No code: Fine clearance Z: Slight preload H: Medium preload	OPTION CODE -K: Equipped with NSK K1™ -K2: Two K1™ Lubrication Units -D: Double Seals -P: Protector Plate

Rail

N1H	30	1200	S	Z
INTERCHANGEABLE RAIL SERIES CODE N1H: NH Series Interchangeable Rail	SIZE	RAIL LENGTH (MM)	MATERIAL CODE No code: Special high carbon steel (NSK standard) S: Stainless steel	PRELOAD CODE Z: Slight preload

MODEL NO.	ASSEMBLY			BALL SLIDE												WIDTH W ₁	HEIGHT H ₁
	HEIGHT H	E	W ₂	WIDTH W	LENGTH L	MOUNTING HOLE			L ₁	K	T	GREASE FITTING					
						B	J	M×PITCH ¹⁾				HOLE SIZE	T ₁	N			
NH15AN NH15BN	28	4.6	9.5	34	55 74	26	26	M4×0.7×6	39 58	23.4	8	∅3	8.5	3.3	15	15	
NH20AN NH20BN	30	5	12	44	69.8 91.8	32	36 50	M5×0.8×6	50 72	25	12	M6×0.75	5	11	20	18	
NH25AN NH25BN	40	7	12.5	48	79 107	35	35 50	M6×1×9	58 86	33	12	M6×0.75	10	11	23	22	
NH30AN NH30BN	45	9	16	60	85.6 124.6	40	40 60	M8×1.25×10	59 98	36	14	M6×0.75	10	11	28	26	
NH35AN NH35BN	55	9.5	18	70	109 143	50	50 72	M8×1.25×12	80 114	45.5	15	M6×0.75	15	11	34	29	
NH45AN NH45BN	70	14	20.5	86	139 171	60	60 80	M10×1.5×17	105 137	56	17	Rc1/8	20	13	45	38	
NH55AN NH55BN	80	15	23.5	100	163 201	75	75 95	M12×1.75×18	126 164	65	18	Rc1/8	21	13	53	44	
NH65AN NH65BN	90	16	31.5	126	193 253	76	70 120	M16×2×20	147 207	74	23	Rc1/8	19	13	63	53	

Notes: 1) External appearance of stainless steel ball slides differs from those of carbon steel ball slides.

Assembly (Preloaded assembly, interchangeable type)

Front view of AN and BN types

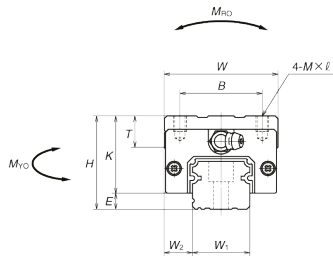

Side view of AN type

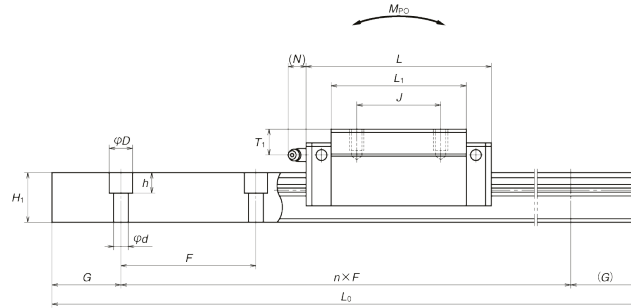

Side view of BN type

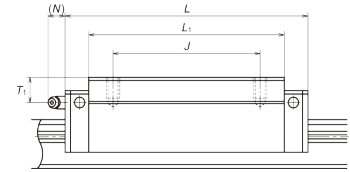

Ball slide of interchangeable type

AN and BN types

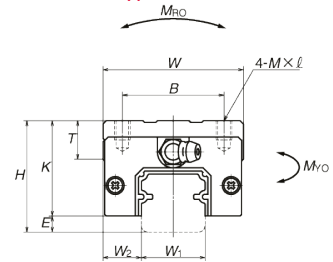

AN type

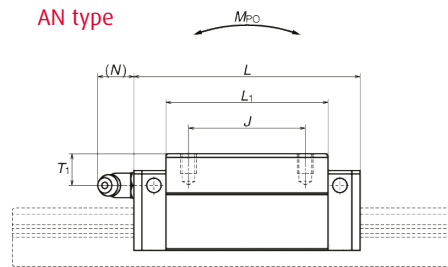

BN type

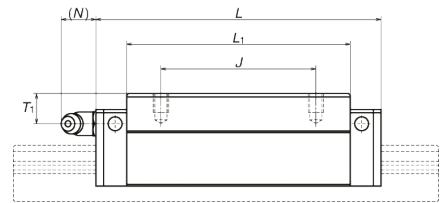

Rail of interchangeable type

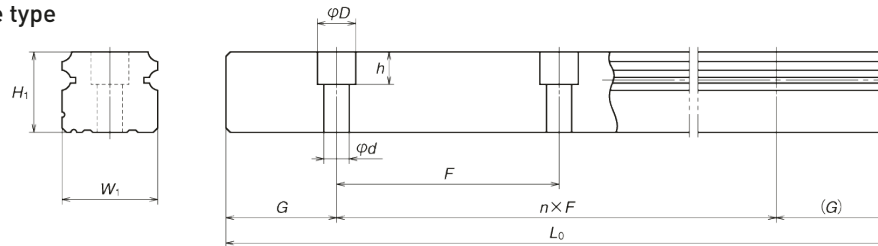

Unit: mm

RAIL				BASIC LOAD RATING								WEIGHT	
PITCH F	MOUNTING BOLT HOLE d×D×H	G (REFERENCE)	MAX. LENGTH L _{OMAX} () FOR STAINLESS	DYNAMIC		STATIC	M _{RO}	STATIC MOMENT (N·M)				BALL SLIDE (KG)	RAIL (KG/M)
				[50KM] C ₅₀ (N)	[100KM] C ₁₀₀ (N)	C ₀ (N)		M _{PO}		M _{YO}			
								(ONE SLIDE)	(TWO SLIDES)	(ONE SLIDE)	(TWO SLIDES)		
60	4.5×7.5×5.3	20	2 980 (1 800)	14 200	11 300	20 700	108	94.5	575	79.5	480	0.18	1.6
				18 100	14 400	32 000	166	216	1 150	181	965	0.26	
60	6×9.5×8.5	20	3 960 (3 500)	23 700	18 800	32 500	219	185	1 140	155	955	0.33	2.6
				30 000	24 000	50 500	340	420	2 230	355	1 870	0.48	
60	7×11×9	20	3 960 (3 500)	33 500	26 800	46 000	360	320	1 840	267	1 540	0.55	3.6
				45 500	36 500	71 000	555	725	3 700	610	3 100	0.82	
80	9×14×12	20	4 000 (3 500)	41 000	32 500	51 500	490	350	2 290	292	1 920	0.77	5.2
				61 000	48 500	91 500	870	1 030	5 600	865	4 700	1.3	
80	9×14×12	20	4 000	62 500	49 500	80 500	950	755	4 500	630	3 800	1.5	7.2
				81 000	64 500	117 000	1 380	1 530	8 350	1 280	7 000	2.1	
105	14×20×17	22.5	3 990	107 000	84 500	140 000	2 140	1 740	9 750	1 460	8 150	3.0	12.3
				131 000	104 000	187 000	2 860	3 000	15 600	2 520	13 100	3.9	
120	16×23×20	30	3 960	158 000	125 000	198 000	3 600	3 000	16 300	2 510	13 700	4.7	16.9
				193 000	153 000	264 000	4 850	5 150	26 300	4 350	22 100	6.1	
150	18×26×22	35	3 900	239 000	190 000	281 000	6 150	4 950	27 900	4 150	23 400	7.7	24.3
				310 000	246 000	410 000	8 950	10 100	51 500	8 450	43 500	10.8	

2) The basic load rating comply with the ISO standard. (ISO14728-1 and ISO14728-2)

C₅₀: the basic dynamic load rating for 50 km rating fatigue life, C₁₀₀: the basic dynamic load rating for 100 km rating fatigue life

DIMENSIONS

NH-AL (HIGH-LOAD TYPE/STANDARD, SQUARE LOW-PROFILE TYPE)
 NH-BL (SUPER-HIGH-LOAD TYPE/LONG, SQUARE LOW-PROFILE TYPE)

(1) Reference number for assembly

NH	30	1200	AL	C	2		P5	3
SERIES NAME	SIZE	RAIL LENGTH (MM)	BALL SLIDE SHAPE CODE (refer to Fig 2 on page 4)	MATERIAL/SURFACE TREATMENT CODE (refer to Table 16 on page 8) C: Special high carbon steel (NSK standard) S: Stainless steel	NUMBER OF BALL SLIDES PER RAIL	DESIGN SERIAL NUMBER (Added to the reference number)	ACCURACY CODE (refer to page 5 and 6)	PRELOAD CODE (refer to page 6) 0: Z0 1: Z1 3: Z3 T: ZT Z: ZZ H: ZH

(2) Reference number for interchangeable type

Ball slide

NAH	30	AL	S	Z	-K
INTERCHANGEABLE BALL SLIDE SERIES CODE NAH: NH Series Interchangeable Ball Slide	SIZE	BALL SLIDE SHAPE CODE (refer to Fig 2 on page 4)	MATERIAL CODE No code: Special high carbon steel (NSK standard) S: Stainless steel	PRELOAD CODE No code: Fine clearance Z: Slight preload H: Medium preload	OPTION CODE -K: Equipped with NSK K1™ -K2: Two K1™ Lubrication Units -D: Double Seals -P: Protector Plate

Rail

N1H	30	1200	S	Z
INTERCHANGEABLE RAIL SERIES CODE N1H: NH Series Interchangeable Rail	SIZE	RAIL LENGTH (MM)	MATERIAL CODE No code: Special high carbon steel (NSK standard) S: Stainless steel	PRELOAD CODE Z: Slight preload

MODEL NO.	ASSEMBLY			BALL SLIDE											WIDTH W ₁	HEIGHT H ₁
	HEIGHT H	E	W ₂	WIDTH W	LENGTH L	MOUNTING HOLE			L ₁	K	T	GREASE FITTING				
						B	J	M×PITCH [≠]				HOLE SIZE	T ₁	N		
NH25AL NH25BL	36	7	12.5	48	79 107	35	35 50	M6×1×6	58 86	29	12	M6×0.75	6	11	23	22
NH30AL NH30BL	42	9	16	60	85.6 124.6	40	40 60	M8×1.25×8	59 98	33	14	M6×0.75	7	11	28	26
NH35AL NH35BL	48	9.5	18	70	109 143	50	50 72	M8×1.25×8	80 114	38.5	15	M6×0.75	8	11	34	29
NH45AL NH45BL	60	14	20.5	86	139 171	60	60 80	M10×1.5×10	105 137	46	17	Rc1/8	10	13	45	38
NH55AL NH55BL	70	15	23.5	100	163 201	75	75 95	M12×1.75×13	126 164	55	15	Rc1/8	11	13	53	44

Notes: 1) External appearance of stainless steel ball slides differs from those of carbon steel ball slides.

Assembly (Preloaded assembly, interchangeable type)

Front view of AL and BL types

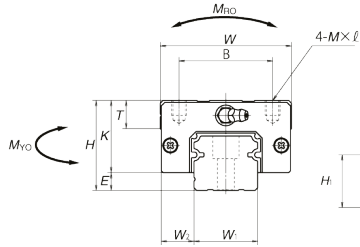

Side view of AL type

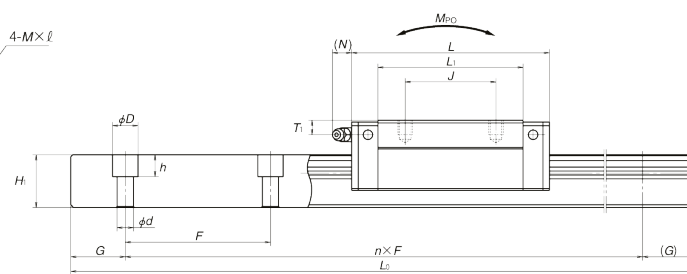

Side view of BL type

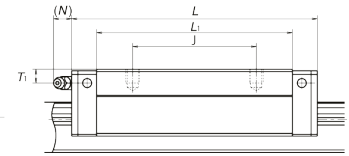

Ball slide of interchangeable type

AL and BL types

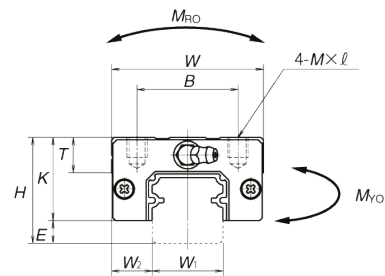

AL type

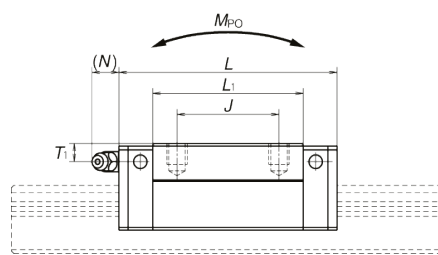

BL type

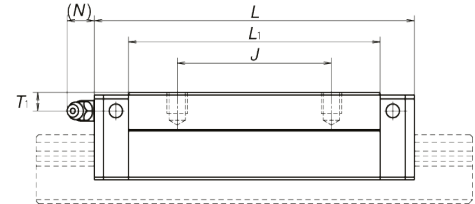

Rail of interchangeable type

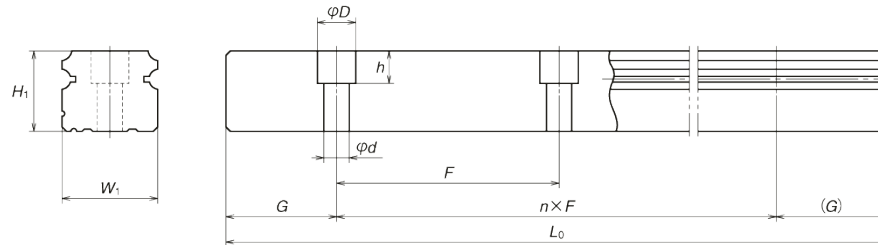

Unit: mm

RAIL				BASIC LOAD RATING								WEIGHT	
PITCH F	MOUNTING BOLT HOLE d×D×H	G (REFERENCE)	MAX. LENGTH L ₀ MAX () FOR STAINLESS	2) DYNAMIC		STATIC	M _{RO}	STATIC MOMENT (N·M)				BALL SLIDE (KG)	RAIL (KG/M)
				[50KM] C ₅₀ (N)	[100KM] C ₁₀₀ (N)	C ₀ (N)		M _{PO}		M _{YO}			
								(ONE SLIDE)	(TWO SLIDES)	(ONE SLIDE)	(TWO SLIDES)		
60	7×11×9	20	3 960 (3 500)	33 500	26 800	46 000	360	320	1 840	267	1 540	0.46	3.6
				45 500	36 500	71 000	555	725	3 700	610	3 100	0.69	
80	9×14×12	20	4 000 (3 500)	41 000	32 500	51 500	490	350	2 290	292	1 920	0.69	5.2
				61 000	48 500	91 500	870	1 030	5 600	865	4 700	1.16	
80	9×14×12	20	4 000	62 500	49 500	80 500	950	755	4 500	630	3 800	1.2	7.2
				81 000	64 500	117 000	1 380	1 530	8 350	1 280	7 000	1.7	
105	14×20×17	22.5	3 990	107 000	84 500	140 000	2 140	1 740	9 750	1 460	8 150	2.2	12.3
				131 000	104 000	187 000	2 860	3 000	15 600	2 520	13 100	2.9	
120	16×23×20	30	3 960	158 000	125 000	198 000	3 600	3 000	16 300	2 510	13 700	3.7	16.9
				193 000	153 000	264 000	4 850	5 150	26 300	4 350	22 100	4.7	

2) The basic load rating comply with the ISO standard. (ISO14728-1 and ISO14728-2)
 C₅₀: the basic dynamic load rating for 50 km rating fatigue life, C₁₀₀: the basic dynamic load rating for 100 km rating fatigue life

DIMENSIONS

NH-EM (HIGH-LOAD TYPE/STANDARD, FLANGE TYPE) NH-GM (SUPER-HIGH-LOAD TYPE/LONG, FLANGE TYPE)

(1) Reference number for assembly

NH	30	1200	EM	C	2		P5	3
SERIES NAME	SIZE	RAIL LENGTH (MM)	BALL SLIDE SHAPE CODE (refer to Fig 2 on page 4)	MATERIAL/SURFACE TREATMENT CODE (refer to Table 16 on page 8) C: Special high carbon steel (NSK standard) S: Stainless steel	NUMBER OF BALL SLIDES PER RAIL	DESIGN SERIAL NUMBER (Added to the reference number)	ACCURACY CODE (refer to page 5 and 6)	PRELOAD CODE (refer to page 6) 0: Z0 1: Z1 3: Z3 T: ZT Z: ZZ H: ZH

(2) Reference number for interchangeable type

Ball slide

NAH	30	EM	S	Z	-K
INTERCHANGEABLE BALL SLIDE SERIES CODE NAH: NH Series Interchangeable Ball Slide	SIZE	BALL SLIDE SHAPE CODE (refer to Fig 2 on page 4)	MATERIAL CODE No code: Special high carbon steel (NSK standard) S: Stainless steel	PRELOAD CODE No code: Fine clearance Z: Slight preload H: Medium preload	OPTION CODE -K: Equipped with NSK K1™ -K2: Two K1™ Lubrication Units -D: Double Seals -P: Protector Plate

Rail

N1H	30	1200	S	Z
INTERCHANGEABLE RAIL SERIES CODE N1H: NH Series Interchangeable Rail	SIZE	RAIL LENGTH (MM)	MATERIAL CODE No code: Special high carbon steel (NSK standard) S: Stainless steel	PRELOAD CODE Z: Slight preload

MODEL NO.	ASSEMBLY			BALL SLIDE										WIDTH	HEIGHT		
	HEIGHT	E	W ₂	WIDTH	LENGTH	MOUNTING HOLE					GREASE FITTING						
						B	J	M×PITCH [×] ✓	Q ₂	L ₁	K	T	HOLE SIZE			T ₁	N
NH15EM NH15GM	24	4.6	16.0	47	55 74	38	30	M5×0.8×7	4.4	39 58	19.4	8	∅3	4.5	3.3	15	15
NH20EM NH20GM	30	5	21.5	63	69.8 91.8	53	40	M6×1×9.5	5.3	50 72	25	10	M6×0.75	5	11	20	18
NH25EM NH25GM	36	7	23.5	70	79 107	57	45	M8×1.25×10 (M8×1.25×11.5)	6.8	58 86	29	11 (12)	M6×0.75	6	11	23	22
NH30EM NH30GM	42	9	31.0	90	98.6 124.6	72	52	M10×1.5×12 (M10×1.5×14.5)	8.6	72 98	33	11 (15)	M6×0.75	7	11	28	26
NH35EM NH35GM	48	9.5	33.0	100	109 143	82	62	M10×1.5×13	8.6	80 114	38.5	12	M6×0.75	8	11	34	29
NH45EM NH45GM	60	14	37.5	120	139 171	100	80	M12×1.75×15	10.5	105 137	46	13	Rc1/8	10	13	45	38
NH55EM NH55GM	70	15	43.5	140	163 201	116	95	M14×2×18	12.5	126 164	55	15	Rc1/8	11	13	53	44
NH65EM NH65GM	90	16	53.5	170	193 253	142	110	M16×2×24	14.6	147 207	74	23	Rc1/8	19	13	63	53

Notes: 1) Parenthesized dimensions are for items made of stainless steel.
2) External appearance of stainless steel ball slides differs from those of carbon steel ball slides.

Assembly (Preloaded assembly, interchangeable type)

Front view of EM and GM types

Side view of EM type

Side view of GM type

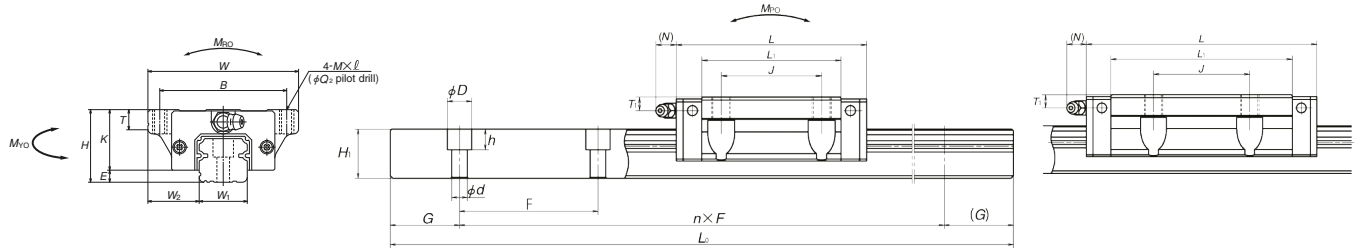

Ball slide of interchangeable type

EM and GM types

EM type

GM type

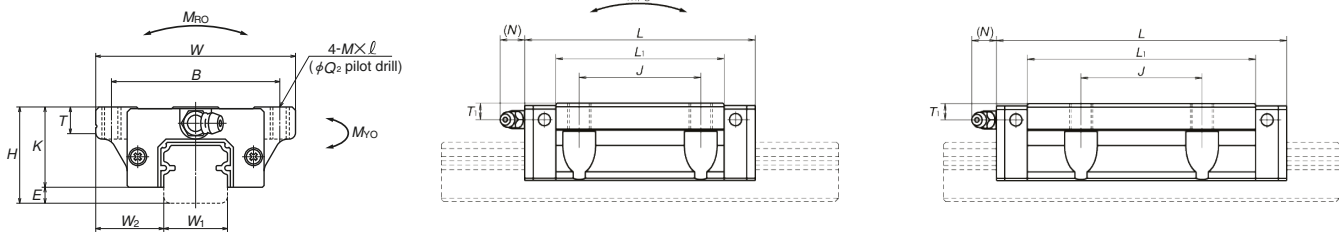

Rail of interchangeable type

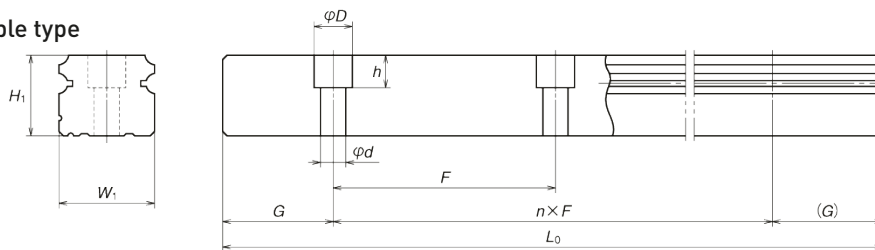

Unit: mm

RAIL				BASIC LOAD RATING								WEIGHT	
PITCH F	MOUNTING BOLT HOLE d×D×H	G (REFERENCE)	MAX. LENGTH L ₀ MAX () FOR STAINLESS	DYNAMIC		STATIC C ₀ (N)	M _{RO}	STATIC MOMENT (N·M)				BALL SLIDE (KG)	RAIL (KG/M)
				[50KM] C ₅₀ (N)	[100KM] C ₁₀₀ (N)			M _{PO}		M _{YO}			
								(ONE SLIDE)	(TWO SLIDES)	(ONE SLIDE)	(TWO SLIDES)		
60	4.5×7.5×5.3	20	2 980	14 200	11 300	20 700	108	94.5	575	79.5	480	0.17	1.6
			(1 800)	18 100	14 400	32 000	166	216	1 150	181	965	0.25	
60	6×9.5×8.5	20	3 960	23 700	18 800	32 500	219	185	1 140	155	955	0.45	2.6
			(3 500)	30 000	24 000	50 500	340	420	2 230	355	1 870	0.65	
60	7×11×9	20	3 960	33 500	26 800	46 000	360	320	1 840	267	1 540	0.63	3.6
			(3 500)	45 500	36 500	71 000	555	725	3 700	610	3 100	0.93	
80	9×14×12	20	4 000	47 000	37 500	63 000	600	505	3 150	425	2 650	1.2	5.2
			(3 500)	61 000	48 500	91 500	870	1 030	5 600	865	4 700	1.6	
80	9×14×12	20	4 000	62 500	49 500	80 500	950	755	4 500	630	3 800	1.7	7.2
				81 000	64 500	117 000	1 380	1 530	8 350	1 280	7 000	2.4	
105	14×20×17	22.5	3 990	107 000	84 500	140 000	2 140	1 740	9 750	1 460	8 150	3.0	12.3
				131 000	104 000	187 000	2 860	3 000	15 600	2 520	13 100	3.9	
120	16×23×20	30	3 960	158 000	125 000	198 000	3 600	3 000	16 300	2 510	13 700	5.0	16.9
				193 000	153 000	264 000	4 850	5 150	26 300	4 350	22 100	6.5	
150	18×26×22	35	3 900	239 000	190 000	281 000	6 150	4 950	27 900	4 150	23 400	10.0	24.3
				310 000	246 000	410 000	8 950	10 100	51 500	8 450	43 500	14.1	

3) The basic load rating comply with the ISO standard. (ISO14728-1 and ISO14728-2)

C₅₀: the basic dynamic load rating for 50 km rating fatigue life, C₁₀₀: the basic dynamic load rating for 100 km rating fatigue life

DIMENSIONS

NS-CL (MEDIUM-LOAD TYPE/SHORT, SQUARE LOW-PROFILE TYPE) NS-AL (HIGH-LOAD TYPE/STANDARD, SQUARE LOW-PROFILE TYPE)

(1) Reference number for assembly

NS	30	1200	AL	C	2		P5	3
SERIES NAME	SIZE	RAIL LENGTH (MM)	BALL SLIDE SHAPE CODE (refer to Fig 2 on page 4)	MATERIAL/SURFACE TREATMENT CODE (refer to Table 16 on page 8) C: Special high carbon steel (NSK standard) S: Stainless steel	NUMBER OF BALL SLIDES PER RAIL	DESIGN SERIAL NUMBER (Added to the reference number)	ACCURACY CODE (refer to page 5 and 6)	PRELOAD CODE (refer to page 6) 0: Z0 1: Z1 3: Z3 T: ZT Z: ZZ H: ZH

(2) Reference number for interchangeable type

Ball slide

NAS	30	AL	S	Z	-K
INTERCHANGEABLE BALL SLIDE SERIES CODE NAS: NS Series Interchangeable Ball Slide	SIZE	BALL SLIDE SHAPE CODE (refer to Fig 2 on page 4)	MATERIAL CODE No code: Special high carbon steel (NSK standard) S: Stainless steel	PRELOAD CODE No code: Fine clearance Z: Slight preload H: Medium preload	OPTION CODE -K: Equipped with NSK K1™ -K2: Two K1™ Lubrication Units -D: Double Seals -P: Protector Plate

Rail

N1S	30	1200	L	S	Z
INTERCHANGEABLE RAIL SERIES CODE N1S: NS Series Interchangeable Rail	SIZE	RAIL LENGTH (MM)	RAIL SHAPE CODE L: Standard T: The rail mounting bolt hole M4 for NS15	MATERIAL CODE No code: Special high carbon steel (NSK standard) S: Stainless steel	PRELOAD CODE Z: Slight preload

MODEL NO.	ASSEMBLY			BALL SLIDE											WIDTH W ₁	HEIGHT H ₁
	HEIGHT			WIDTH W	LENGTH L	MOUNTING HOLE			L ₁	K	T	GREASE FITTING				
	H	E	W ₂			B	J	M×PITCH \neq				HOLE SIZE	T ₁	N		
NS15CL NS15AL	24	4.6	9.5	34	40.4 56.8	26	— 26	M4×0.7×6	23.6 40	19.4	10	∅3	6	3	15	12.5
NS20CL NS20AL	28	6	11	42	47.2 65.2	32	— 32	M5×0.8×7	30 48	22	12	M6×0.75	5.5	11	20	15.5
NS25CL NS25AL	33	7	12.5	48	59.6 81.6	35	— 35	M6×1×9	38 60	26	12	M6×0.75	7	11	23	18
NS30CL NS30AL	42	9	16	60	67.4 96.4	40	— 40	M8×1.25×12	42 71	33	13	M6×0.75	8	11	28	23
NS35CL NS35AL	48	10.5	18	70	77 108	50	— 50	M8×1.25×12	49 80	37.5	14	M6×0.75	8.5	11	34	27.5

Notes: 1) External appearance of stainless steel ball slides differs from those of carbon steel ball slides.
2) The basic load rating comply with the ISO standard. (ISO14728-1 and ISO14728-2)
C₅₀: the basic dynamic load rating for 50 km rating fatigue life, C₁₀₀: the basic dynamic load rating for 100 km rating fatigue life

Assembly (Preloaded assembly, interchangeable type)

Front view of AL and CL types

Side view of AL type

Side view of CL type

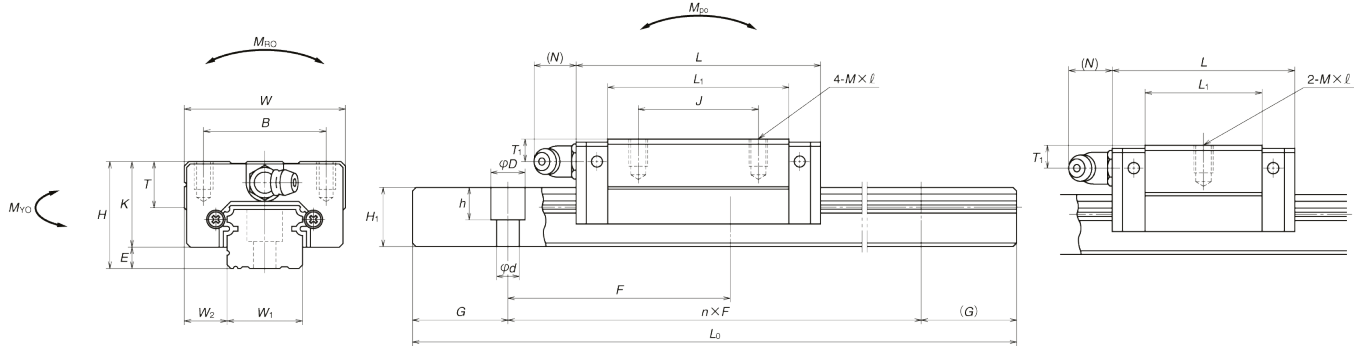

Ball slide of interchangeable type

AL and CL types

AL type

CL type

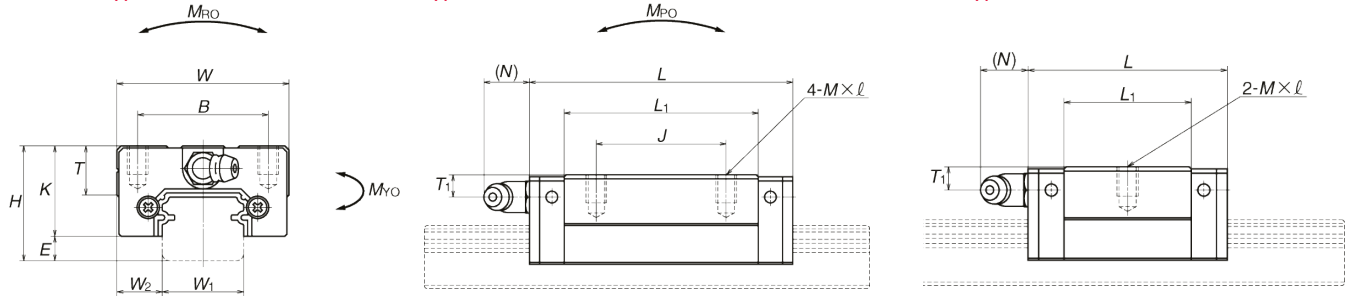

Rail of interchangeable type

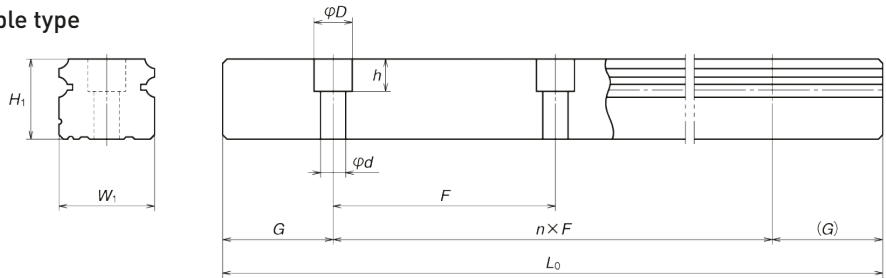

Unit: mm

RAIL				BASIC LOAD RATING							WEIGHT		
PITCH F	MOUNTING BOLT HOLE d×D×H	G (REFERENCE)	MAX. LENGTH L _{OMAX} (°) FOR STAINLESS	DYNAMIC		STATIC	M _{RO}	STATIC MOMENT (N·M)				BALL SLIDE (KG)	RAIL (KG/M)
				[50KM] C ₅₀ (N)	[100KM] C ₁₀₀ (N)	C ₀ (N)		M _{PO}		M _{YO}			
60	*3.5×6×4.5 4.5×7.5×5.3	20	2 920 (1 700)	7 250	5 750	9 100	45.5	24.5	196	20.5	165	0.14	1.4
				11 200	8 850	16 900	84.5	77	470	64.5	395		
60	6×9.5×8.5	20	3 960 (3 500)	10 600	8 400	13 400	91.5	46.5	330	39	279	0.19	2.3
				15 600	12 400	23 500	160	133	755	111	630		
60	7×11×9	20	3 960 (3 500)	17 700	14 000	20 800	164	91	655	76	550	0.34	3.1
				26 100	20 700	36 500	286	258	1 470	217	1 230		
80	7×11×9	20	4 000 (3 500)	24 700	19 600	29 600	282	139	1 080	116	905	0.58	4.8
				38 000	30 000	55 000	520	435	2 650	365	2 220		
80	9×14×12	20	4 000 (3 500)	34 500	27 300	40 000	465	220	1 670	185	1 400	0.86	7.0
				52 500	42 000	74 500	865	695	4 000	580	3 350		

* Standard rail mounting bolt hole for NS15 is specified as hole for M3 (3.5 x 6 x 4.5).
Please contact NSK to request a different hole for M4 (4.5 x 7.5 x 5.3).

DIMENSIONS

NS-JM (MEDIUM-LOAD TYPE/SHORT, FLANGE TYPE) NS-EM (HIGH-LOAD TYPE/STANDARD, FLANGE TYPE)

(1) Reference number for assembly

NS	30	1200	EM	C	2		P5	3
SERIES NAME	SIZE	RAIL LENGTH (MM)	BALL SLIDE SHAPE CODE (refer to Fig 2 on page 4)	MATERIAL/SURFACE TREATMENT CODE (refer to Table 16 on page 8) C: Special high carbon steel (NSK standard) S: Stainless steel	NUMBER OF BALL SLIDES PER RAIL	DESIGN SERIAL NUMBER (Added to the reference number)	ACCURACY CODE (refer to page 5 and 6)	PRELOAD CODE (refer to page 6) 0: Z0 1: Z1 3: Z3 T: ZT Z: ZZ H: ZH

(2) Reference number for interchangeable type

Ball slide

NAS	30	EM	S	Z	-K
INTERCHANGEABLE BALL SLIDE SERIES CODE NAS: NS Series Interchangeable Ball Slide	SIZE	BALL SLIDE SHAPE CODE (refer to Fig 2 on page 4)	MATERIAL CODE No code: Special high carbon steel (NSK standard) S: Stainless steel	PRELOAD CODE No code: Fine clearance Z: Slight preload H: Medium preload	OPTION CODE -K: Equipped with NSK K1™ -K2: Two K1™ Lubrication Units -D: Double Seals -P: Protector Plate

Rail

N1S	30	1200	L	S	Z
INTERCHANGEABLE RAIL SERIES CODE N1S: NS Series Interchangeable Rail	SIZE	RAIL LENGTH (MM)	RAIL SHAPE CODE L: Standard T: The rail mounting bolt hole M4 for NS15	MATERIAL CODE No code: Special high carbon steel (NSK standard) S: Stainless steel	PRELOAD CODE Z: Slight preload

MODEL NO.	ASSEMBLY			BALL SLIDE													
	HEIGHT H	E	W ₂	WIDTH W	LENGTH L	MOUNTING HOLE				L ₁	K	T	GREASE FITTING			WIDTH W ₁	HEIGHT H ₁
						B	J	M×PITCH ¹⁾	Q ₂				HOLE SIZE	T ₁	N		
NS15JM NS15EM	24	4.6	18.5	52	40.4 56.8	41	— 26	M5×0.8×7	4.4	23.6 40	19.4	8	∅3	6	3	15	12.5
NS20JM NS20EM	28	6	19.5	59	47.2 65.2	49	— 32	M6×1×9 (M6×1×9.5)	5.3	30 48	22	10	M6×0.75	5.5	11	20	15.5
NS25JM NS25EM	33	7	25	73	59.6 81.6	60	— 35	M8×1.25×10 (M8×1.25×11.5)	6.8	38 60	26	11 (12)	M6×0.75	7	11	23	18.0
NS30JM NS30EM	42	9	31	90	67.4 96.4	72	— 40	M10×1.5×12 (M10×1.5×14.5)	8.6	42 71	33	11 (15)	M6×0.75	8	11	28	23.0
NS35JM NS35EM	48	10.5	33	100	77 108	82	— 50	M10×1.5×13 (M10×1.5×14.5)	8.6	49 80	37.5	12 (15)	M6×0.75	8.5	11	34	27.5

Notes: 1) External appearance of stainless steel ball slides differs from those of carbon steel ball slides.
2) Parenthesized dimensions are for items made of stainless steel.

Assembly (Preloaded assembly, interchangeable type)

Front view of EM and JM types

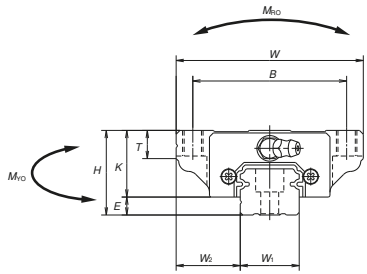

Side view of EM type

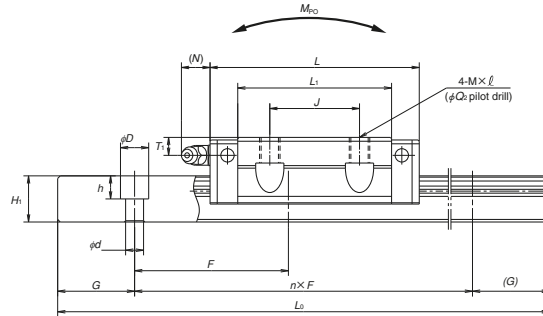

Side view of JM type

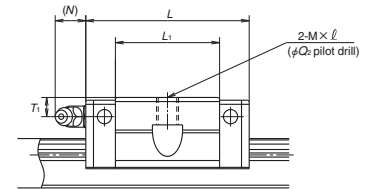

Ball slide of interchangeable type

EM and JM types

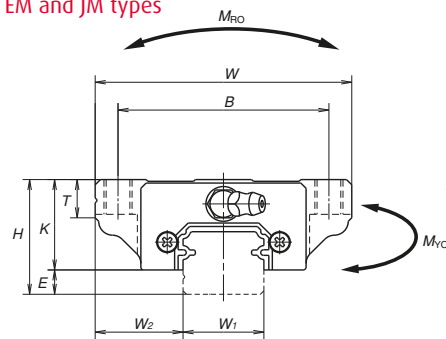

EM type

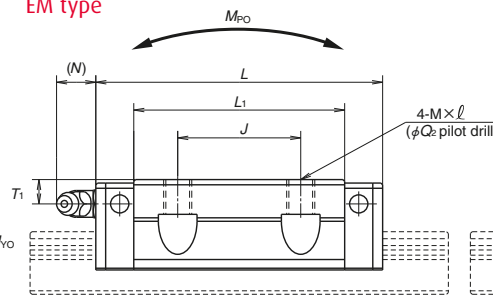

JM type

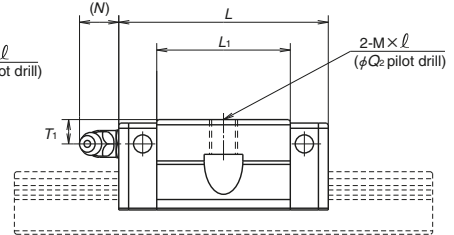

Rail of interchangeable type

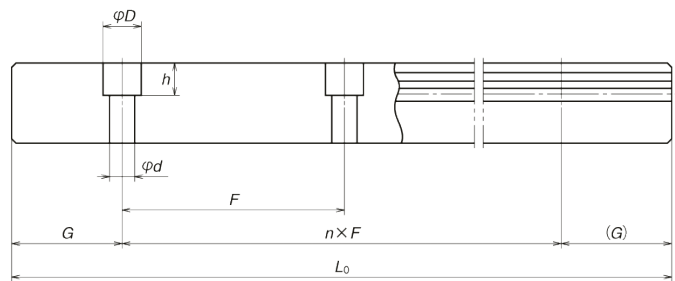
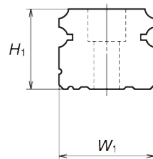

Unit: mm

RAIL				BASIC LOAD RATING								WEIGHT	
PITCH F	MOUNTING BOLT HOLE d×D×H	G (REFERENCE)	MAX. LENGTH L ₀ MAX () FOR STAINLESS	³⁾ DYNAMIC		STATIC	M _{RO}	STATIC MOMENT (N·M)				BALL SLIDE (KG)	RAIL (KG/M)
				[50KM] C ₅₀ (N)	[100KM] C ₁₀₀ (N)	C ₀ (N)		M _{PO}		M _{YO}			
								(ONE SLIDE)	(TWO SLIDES)	(ONE SLIDE)	(TWO SLIDES)		
60	*3.5×6×4.5 4.5×7.5×5.3	20	2 920 (1 700)	7 250	5 750	9 100	45.5	24.5	196	20.5	165	0.17	1.4
				11 200	8 850	16 900	84.5	77	470	64.5	395	0.26	
60	6×9.5×8.5	20	3 960 (3 500)	10 600	8 400	13 400	91.5	46.5	330	39	279	0.24	2.3
				15 600	12 400	23 500	160	133	755	111	630	0.35	
60	7×11×9	20	3 960 (3 500)	17 700	14 000	20 800	164	91	655	76	550	0.44	3.1
				26 100	20 700	36 500	286	258	1 470	217	1 230	0.66	
80	7×11×9	20	4 000 (3 500)	24 700	19 600	29 600	282	139	1 080	116	905	0.76	4.8
				38 000	30 000	55 000	520	435	2 650	365	2 220	1.2	
80	9×14×12	20	4 000 (3 500)	34 500	27 300	40 000	465	220	1 670	185	1 400	1.2	7
				52 500	42 000	74 500	865	695	4 000	580	3 350	1.7	

3) The basic load rating comply with the ISO standard. (ISO14728-1 and ISO14728-2)

C₅₀: the basic dynamic load rating for 50 km rating fatigue life, C₁₀₀: the basic dynamic load rating for 100 km rating fatigue life

*) Standard rail mounting bolt hole for NS15 is specified as hole for M3 (3.5 x 6 x 4.5).

Please contact NSK to request a different hole for M4 (4.5 x 7.5 x 5.3).



NSK AMERICAS

United States

NSK Corporation
Ann Arbor MI
1.888.446.5675

Canada

NSK Canada Inc.
Mississauga ON
1.888.603.7667

Mexico

NSK Rodamientos Mexicana,
S.A. de C.V.
Silao Guanajuato MX
52.472.500.9500

Brazil

NSK Brasil Ltda.
Sao Paulo SP
55.11.3269.4700

Argentina

NSK Argentina SRL
Buenos Aires
54.11.4762.6556

Latin America

NSK Latin America Inc.
Miramar FL
1.305.477.0605

NSK Americas:

www.nskamericas.com

NSK Global:

www.nsk.com

Every care has been taken to ensure the accuracy of the data contained in this brochure, but no liability can be accepted for any loss or damage suffered through errors or omissions.

Printed in the USA ©NSK 2023. The contents of this publication are the copyright of the publishers.